

FALL-OUT DUST LEVELS AROUND TWO ENTERPRISES IN THE WESTERN CAPE OF SOUTH AFRICA FROM 2001 TO 2005

Christopher Loans

A research report submitted to the Faculty of Science, University of the Witwatersrand, Johannesburg, in partial fulfilment of the requirements for the degree of Master of Public Health.

Cape Town, 2007

DECLARATION

I declare that this research report is my own, unaided work. It is being submitted for the Degree of Master of Public Health in the University of the Witwatersrand, Johannesburg. It has not been submitted before for any degree or examination in any other University.

I have received statistical analysis assistance from Pilate Moyo:

Pilate Moyo, BSc Eng, MSc Eng, PhD.
Department of Civil Engineering
University of Cape Town
Rondebosch 7701 X3
Cape Town
Republic of South Africa
E-mail pmoyo@ebe.uct.ac.za
Tel +27-21-6502592, Fax +27-21-6897471

I have also received assistance from my two supervisors, Professor Tony Davies and Professor David Rees.

Gerry Kuhn Environmental and Hygiene Engineering obtained the data used in this thesis while they employed me. I have hands on experience with the sampling procedures used to collect the data and wrote monthly reports for all the clients monitoring for precipitant dust.

Nikki Loans assisted with the grammar and sentence structure edit.



(Signature of candidate)

This 6th day of October 2007

ABSTRACT

Looking up at the sky, we would never guess that our atmosphere contains between one and three billion tons of dust and other particles at any given time.¹ Wind assists in keeping this dust airborne, but gravity wins most of the time, forcing the dust particles earthward, proving the old adage: “what goes up, must come down.”

Precipitant dust levels in the Western Cape do not follow the same pattern as the precipitant dust levels in the summer rainfall areas of South Africa. Due to the very dry summer conditions in the Western Cape, the precipitant dust levels can be very high, especially if sources of fugitive dust are ignored.

An environmental consulting company positioned precipitant dust monitoring units at strategic locations, taking process and open dust sources into account. Both wet and dry depositions have been reported on in this report as one figure. Seasonal changes in, and long-term trends of, the amount of precipitant dust were documented and statistically analysed to determine if the precipitant dust levels were above the South African legislated action levels.

The particle size analysis performed on the precipitant dust indicated that the dust was predominantly less than 100 μm and that about 22 percent of the particles by volume were under 15 μm .

No significant decline in the precipitant dust levels around the calcining industry was noted. Recommendations are that they increase the dust control measures on site, especially near to the DHF sampling location.

There was a significant decrease in the precipitant dust levels to the north and south of the smelting industry from October 2001 to April 2005, p-value 0.005 and 0.048. The recommendations for the smelting industry are that they continue to eliminate fugitive dust sources and that they continue to maintain a high awareness of dust control.

DEDICATION

Dedicated to the Creator of the Universe, THE LORD.

Also dedicated to my wife, Nikki and my children, Matthew and Amy-Grace.

ACKNOWLEDGEMENTS

I would like to thank Gerry Kuhn Environmental and Hygiene Engineering for diligently collecting the data used in this research report.

I would also like to thank the industries that allowed their fall-out dust data to be used as part of the research report.

I would like to thank the South African Weather Service www.weathersa.co.za for supplying weather data covering the time period of this thesis. The information provided by the South African Weather Service was outstanding.

I would like to thank Nikki Loans, who helped me edit the document.

I would like to thank Pilate Moyo for the statistical advice given.

I would like to thank Prof. David Rees, one of my supervisors, for the statistical advice given.

I would also like to thank my supervisors for their input, Professor Tony Davies and Professor David Rees who work for the National Institute of Occupational Health in South Africa.

TABLE OF CONTENTS

1	INTRODUCTION AND LITERATURE REVIEW	1
1.1	Where Dust Comes From	1
1.2	Dust Terminology, Environmental, and Health Implications	1
1.3	Measurement Methods for Atmospheric Dust	3
1.4	Sources of Dust and Climatic Conditions Specific to the Western Cape	4
1.5	Precipitant Dust Measurements and Standards	6
1.6	Export Bucket Definition and DustWatch Technology	8
1.7	General Comments and Study Objectives	9
2	METHODS AND MATERIALS USED	11
2.1	Study Design	11
2.2	Description of the Enterprises and Monitoring Positions	12
2.3	Sample Preparation Method and Laboratory Analysis	17
2.4	Quality Control	18
2.5	Particle Size Analysis	21
2.6	Data Handling and Analysis	22
2.7	Ethics	24
3	RESULTS	25
3.1	Descriptive Statistics for the Precipitant Dust Concentrations	26
3.2	Particle Size Analysis of Four Precipitant Dust Samples from the Calcining Industry.	45
3.3	Trend Analysis of Precipitant Dust Data	51
3.3.1	Precipitant Dust Concentrations for the Export Buckets at the Smelting Industry over the Warm-dry Periods	51
3.3.2	Precipitant Dust Concentrations for the Export Buckets at the Calcining Industry over the Warm-dry Periods.	53
3.3.3	Chi Square Test for Trend Results of the Export Buckets for each Sampling Location at the Smelting Industry	58
3.3.4	Chi Square Test for Trend Results of the Export Buckets for each Sampling Location at the Calcining Industry	58
4	DISCUSSION	60
4.1	Summary of the Main Findings	60
4.2	Limitations of this Study	61
4.3	Industry and Community View Points on Precipitant Dust	61
4.4	Descriptive Analysis of the Precipitant Dust Data	63

4.4.1	Smelting Industry _____	63
4.4.2	Calcining Industry _____	64
4.4.3	South African Legislation Implications _____	65
4.5	Particle Size Analysis of the Precipitant Dust Samples _____	68
4.6	Smelting Industry - Precipitant Dust Data Trends _____	70
4.6.1	SG Precipitant Dust Sampling Location _____	70
4.6.2	SO Precipitant Dust Sampling Location _____	70
4.7	Calcining Industry - Precipitant Dust Data Trends _____	71
5	CONCLUSIONS AND RECOMMENDATIONS FOR FUTURE STUDY _____	72
5.1	Considerations for Future Studies _____	73
6	REFERENCES _____	76
APPENDIX A. Step by Step Description of the Method Used to Obtain the Precipitant Dust Data. _____		80
1.	Bucket Preparation _____	80
2.	Bucket Collection Procedure _____	81
3.	Filtering Procedure _____	82
4.	Weighing Procedure – Filter Preparation _____	83
5.	Weighing Procedure – Filter/Filtrate Weighing _____	83
6.	Calculations _____	84
7.	Limitations of Sampling and Filter materials _____	85
APPENDIX B. Filtering System Layout _____		88
APPENDIX C. Precipitant Dust Data for the Smelting Industry _____		90
APPENDIX D. Precipitant Dust Data for the Calcining Industry _____		92
APPENDIX E. Ethics form from the Ethics Committee _____		85

LIST OF FIGURES

Figure 1: Positions of the eight precipitant dust-monitoring units at the calcining industry. _____	15
Figure 2: Positions of the two precipitant dust-monitoring positions at the smelting industry. _____	16
Figure 3: Distribution of precipitant dust for the north and south buckets of the SG and SO sampling locations for 2001 to 2005. Warm-dry and cold-wet measurements are combined. _____	32
Figure 4: Distribution of precipitant dust ($\text{mg m}^{-2} \text{d}^{-1}$) for the north, south, east, and west buckets of the GAT, GCD, RWD, and KF sampling locations for 2001 to 2005. Warm-dry and cold-wet measurements are combined. _____	33
Figure 5: Distribution of warm-dry precipitant dust ($\text{mg m}^{-2} \text{d}^{-1}$) for the north and south buckets of the SG and SO sampling locations for 2001 to 2005. _____	38
Figure 6: Distribution of cold-wet precipitant dust ($\text{mg m}^{-2} \text{d}^{-1}$) for the north and south buckets of the SG and SO sampling locations for 2001 to 2005. _____	39
Figure 7: Distribution of warm-dry precipitant dust ($\text{mg m}^{-2} \text{d}^{-1}$) for the north, south, east, and west buckets of the GAT, GCD, RWD, and KF sampling locations for 2001 to 2005. _____	40
Figure 8: Distribution of cold-wet precipitant dust ($\text{mg m}^{-2} \text{d}^{-1}$) for the north, south, east, and west buckets of the GAT, GCD, RWD, and KF sampling locations for 2001 to 2005. _____	40
Figure 9: Particle size analysis of the north bucket at the GAT sampling location. _____	47
Figure 10: Particle size analysis of the south bucket at the GCD sampling location. _____	48
Figure 11: Particle size analysis of the east bucket at the RWD sampling location. _____	49

Figure 12: Particle size analysis of the west bucket at the KF sampling location. _____	50
Figure 13: Precipitant dust data for the warm-dry periods for the north bucket of the SG sampling location at the smelting industry. _____	52
Figure 14: Precipitant dust data for the warm-dry periods for the South bucket of the SO sampling location at the smelting industry. _____	52
Figure 15: Precipitant dust data for the warm-dry periods for the south bucket of the 4SS sampling location at the calcining industry. _____	53
Figure 16: Precipitant dust data for the warm-dry periods for the north bucket of the GAT sampling location at the calcining industry. _____	54
Figure 17: Precipitant dust data for the warm-dry periods for the south bucket of the DHF sampling location at the calcining industry. _____	54
Figure 18: Precipitant dust data for the warm-dry periods for the west bucket of the KF sampling location at the calcining industry. _____	55
Figure 19: Precipitant dust data for the warm-dry periods for the north bucket of the QD sampling location at the calcining industry. _____	56
Figure 20: Precipitant dust data for the warm-dry periods for the south bucket of the GCD sampling location at the calcining industry. _____	56
Figure 21: Precipitant dust data for the warm-dry periods for the south bucket of the MD sampling location at the calcining industry. _____	57
Figure 22: Precipitant dust data for the warm-dry periods for the east bucket of the RWD sampling location at the calcining industry. _____	57
Figure 23: Cradle of the DustWatch unit that holds the buckets _____	86
Figure 24: Exploded layout of the DustWatch unit _____	87
Figure 25: Filtering system layout and description _____	89
Figure 26: Precipitant dust data for the SG sampling area _____	90

Figure 27: Precipitant dust data for the SO sampling area	91
Figure 28: Precipitant dust data for the KF sampling area	92
Figure 29: Precipitant dust data for the DHF sampling area	93
Figure 30: Precipitant dust data for the 4SS sampling area	94
Figure 31: Precipitant dust data for the GAT sampling area	95
Figure 32: Precipitant dust data for the QD sampling area	96
Figure 33: Precipitant dust data for the GCD sampling area	97
Figure 34: Precipitant dust data for the MD sampling area	98
Figure 35: Precipitant dust data for the RWD sampling area	99

LIST OF TABLES

Table 1: Classification of areas in terms of sensitivity to precipitant dust ⁵	3
Table 2: Dustfall standards SANS (2005)	7
Table 3: Precipitant dust measurements ($\text{mg m}^{-2} \text{d}^{-1}$) over 2001 to 2005 for the smelting industry for each direction at both sampling locations. The highlighted rows are the export directions at each sampling location.	28
Table 4: Precipitant dust measurements ($\text{mg m}^{-2} \text{d}^{-1}$) over 2001 to 2005 for the calcining industry for each direction at the different sampling locations. The highlighted rows are the export directions at each sampling location.	30
Table 5: Precipitant dust measurements ($\text{mg m}^{-2} \text{d}^{-1}$) over 2001 to 2005 for the smelting industry for each export bucket at the sampling locations of the smelting industry in the warm-dry period and the cold-wet period.	34
Table 6: Precipitant dust measurements ($\text{mg m}^{-2} \text{d}^{-1}$) over 2001 to 2005 for the calcining industry for each export bucket at the sampling locations of the calcining industry in the warm-dry period and the cold-wet period.	36
Table 7: Number and percentages of warm-dry precipitant dust measurements above $600 \text{ mg m}^{-2} \text{d}^{-1}$ and above $1200 \text{ mg m}^{-2} \text{d}^{-1}$ by year for the export bucket at each sampling location of the smelting industry. The total number of measurements for each year is 13 for the warm dry period and 13 for the cold-wet period.	41
Table 8: Number and percentages of warm-dry precipitant dust measurements above $600 \text{ mg m}^{-2} \text{d}^{-1}$ and above $1200 \text{ mg m}^{-2} \text{d}^{-1}$ by year for the export bucket at the 4SS, GAT, DHF, and KF sampling locations of the calcining industry. The total number of measurements for each year is 13 for the warm dry period and 13 for the cold-wet period.	42
Table 9: Number and percentages of warm-dry precipitant dust measurements above $600 \text{ mg m}^{-2} \text{d}^{-1}$ and above $1200 \text{ mg m}^{-2} \text{d}^{-1}$	

by year for the export bucket at each of the sampling locations of the calcining industry. The total number of measurements for each year is 13 for the warm dry period and 13 for the cold-wet period. ----- 44

Table 10: Amount of water required for different climatic conditions. 80

NOMENCLATURE

- 4SS – One of the sampling locations to the north of the calcining industry in a residential area.
- Aerodynamic diameter is the diameter of a spherical particle that has a density of 1g/cm^3 and which has the same terminal settling velocity as the particle of interest.
- ANOVA – Analysis of Variance of Means
- Atmospheric dust – Dust that is in the atmosphere.
- Brownian Motion – The continual random movement, due to molecular agitation, of fine particles suspended in a gas or a liquid.
- Calcining – Calcining is the conversion of the physical or chemical properties of a substance by the application of heat.
- Cold-wet Period – Used to indicate the months from April to September.
- d50 – In a sample of dust the d50 diameter is the diameter above which fifty percent of the particles are larger, and below which fifty percent of the particles are smaller.
- DHF – One of the sampling locations around the calcining industry, on a local farm.
- Dry deposition – The collection of precipitant dust during periods with no rainfall.
- Export bucket – The export bucket can be the north, south, east or west bucket that is closest to the dust sources. When the wind blows over the dust source towards the sampling location then the export bucket is open and dust from the dust source is collected in the bucket.
- Fall-out dust – See precipitant dust.
- Fugitive dust – Dust that is not emitted from a point source that can be easily defined such as stacks. Sources are open fields, travel ways, stockpiles and process buildings.
- GAT – One of the sampling locations around the calcining industry.
- GCD – One of the sampling locations around the calcining industry.
- Indeterminate error – An error where there is no way to determine the size or sign of the error in any individual measurement.

- KF – One of the sampling locations on a nearby farm to the north-east of the calcining industry.
- MD – One of the sampling locations around the calcining industry.
- Meteorology – the earth science dealing with phenomena of the atmosphere (especially weather).
- New bucket – A bucket that is going into the field to replace an old bucket.
- Occult deposition – Increasing particle size due to moisture that results in deposition due to increased mass of particle.
- Old bucket – A bucket that has been in the field for two weeks and is being replaced by a new bucket.
- Petri dish – A container used to keep the precipitant dust samples free of contamination after they have been filtered.
- PM_{2.5} – Sampling of atmospheric dust where the aerodynamic d50 diameter is 2.5 μm .
- PM₁₀ – Sampling of atmospheric dust where the aerodynamic d50 diameter is 10 μm .
- Precipitant dust – Any particulate matter that has an aerodynamic diameter below 100 μm .
- QD – A sampling location in the quarry of the calcining industry.
- RCT - Replaceable countertop. Referring to the water filtration cartridge that is totally replaced when it expires.
- RWD – One of the sampling locations around the calcining industry.
- SG – The sampling location to the south of the smelting industry.
- SO – The sampling location to the north of the smelting industry.
- Summer – In some of the graphs and tables the term summer has been used to indicate the warm-dry period.
- Total deposition – The sum of wet and dry deposition. Occult deposition is also included.
- Two-week data – Each data point is representative of a two week period.
- Warm-dry period – Used to indicate the months from October to March.

- Wet deposition – The collection of precipitant dust and any soluble substances in the rainwater during periods of rainfall.
- Winter – In some of the graphs and tables, the term winter has been used to indicate the cold-wet period.

1 INTRODUCTION AND LITERATURE REVIEW

In this chapter precipitant dust particles are defined and health implications are reviewed. The standard method used as a basis for precipitant dust monitors is also reviewed. This is followed by a description of the various dust sources common to the Western Cape and how climatic conditions affect precipitant dust levels. The different types of dust precipitation are also discussed and the chapter ends with the aims and objectives of the study described in this research report.

1.1 Where Dust Comes From

Looking up at the sky, we would never guess that our atmosphere contains between one and three billion tons of dust and other particles at any given time.¹ Wind assists in keeping this dust airborne, but gravity wins most of the time, forcing the dust particles earthward, proving the old adage: “what goes up, must come down.”

Dust comes from many different sources. Some, like the by-products of the combustion of fossil fuels, are man-made.¹ Others come from natural sources – like sea-spray blowing off the ocean, or dust blowing in from the desert.¹ Dust comprises inorganic matter, such as sand particles, as well as a large amount of organic matter, including pollen, spores, moulds, and viruses². These minute particles, ranging in size from around 100 micro metres (μm) to a few nano metres (nm)³, invade our airspace every day, a part of life that we aren't even aware of, except when we dust the furniture!¹

1.2 Dust Terminology, Environmental, and Health Implications

The different terminology used to describe dust can be quite confusing with different names being given for different size fractions of dust. For the purpose of this report, fall-out or

precipitant dust refers to any particle with an aerodynamic diameter less than 100 μm .

Precipitant dust is broadly defined as particulate that ranges in size up to 100 μm in diameter.⁴ If the particles settle by gravity then they are collected as dry deposition. Alternatively, if it rains, then the particles are collected as wet deposition. Total precipitant dust is the sum of dry and wet deposition. The coarse fraction precipitant dust, generated by mechanical disturbance or wind erosion, usually lands on the ground within a one-kilometre radius⁵ of the source, although with thermals and high wind speeds, dust of this size can be blown significantly further.⁶ Precipitant dust emitted from a stack can travel varying distances depending on the height of the stack above the ground, the size of the particles emitted and the topography of the area.

Particles between 10 and 100 μm usually lose altitude as a result of gravity⁴. These particles can be lifted up by strong winds but when the wind stops lifting the particles up into the air, they begin to settle. Smaller particles (less than 10 μm) are affected by thermals, turbulence and Brownian motion⁷ and will not necessarily settle all the way to ground level. These particles are nevertheless present in the atmosphere at all altitudes and they also precipitate when climatic conditions are suitable.⁴

For residents living near to significant precipitant dust sources, the precipitant dust is a concern both from an environmental and “quality of life”⁵ point of view.^{5,8}

Dust particles less than 40 μm in size can be deposited in the nasal passage⁹ and this can contribute to allergies, sensitisations, and asthma.¹⁰

Precipitant dust is generally regarded as benign, although there are some exceptions.¹¹ The current trend from a health point of view is to monitor for smaller particulate matter (PM_{10}). The health impacts of precipitant dust are not well understood and research in this regard is ongoing.⁵

Each site is unique and the impact of the precipitant dust emanating from a mine or factory is dependent on many factors:

- The type of mineral being processed and the methods used. ⁵
- Local meteorology and topography. ⁵
- The zoning of the land surrounding the site, as shown in Table 1. ⁵

Table 1: Classification of areas in terms of sensitivity to precipitant dust⁵

High Sensitivity	Medium Sensitivity	Low Sensitivity
Hospitals and clinics	Schools	Farms
Retirement homes	Residential areas	Light and heavy industry
Hi-tech industries	Food retailers	Outdoor storage
Areas where painting is being done	Greenhouses and nurseries	
Food processing	Horticultural land	
	Offices	

1.3 Measurement Methods for Atmospheric Dust

The present method to establish precipitant dust levels is the ASTM (American Standard Test Method) D-1739 of 1998 “Standard Method for Collection and Analysis for Dust Fall (Settleable particulates)” ¹².

There are many measurements that can be used to quantify fugitive dust concentrations. The use of precipitant dust level measurements is suitable to the South African economy where finances for instruments that measure continuously from the atmosphere are not usually available.

While single open buckets partly-filled with a capture medium will accumulate all precipitating dust, this does not establish precipitant dust emanating from a given direction unless the bucket is closed to any dust from other directions¹³. Such open buckets are also subject to inaccuracies due to wind turbulence within the buckets, lower air densities over the bucket and other factors¹³. The single

bucket precipitant dust collection method¹² “is a crude and non-specific test method, but it is useful in the study of long term trends.”¹²

There are many different types of equipment that are used to monitor precipitant dust levels. Gerry Kuhn Environmental and Hygiene Engineering have used a method^{12,14} based on the American Standard Test Method¹². The equipment used to measure the dust is called the “DustWatch” unit¹⁴. The unit is wind operated and different buckets open under different wind conditions. The unit has four buckets that are used for directional identification of localised dust sources as well as to identify ambient precipitant dust concentrations¹⁴.

1.4 Sources of Dust and Climatic Conditions Specific to the Western Cape

The impact that climatic conditions have on the precipitant dust levels is important and the factors that could be considered are rainfall (drought), wind speed, and the time periods with little or no wind.

“Depending on climate conditions and topography, fine particles may remain airborne for days or months and may be transported 1000 to 10 000 km or more from their source”¹⁵.

There is almost always a heavier load of precipitant dust locally around the source, but this does not mean that the areas further away are not affected.¹⁶

The interaction between wind and dust is very complicated⁶ and the norm is to assume that dust levels are higher when wind speeds are higher, but this is not always the case¹⁷ and high dust levels have also been found to correlate poorly with wind direction in certain situations¹⁷. The wind direction also changes with altitude⁶, resulting in ground level dust being generated by wind from one direction, only for the wind at a higher altitude to blow the dust in a different direction.⁶ This is particularly relevant when the dust is being emitted from a stack, a very high stockpile or elevated

conveyors. Dust exiting tall buildings will also be distributed according to the wind pattern around the building.

The sources of industrial precipitant dust are broadly categorised as either generated by processes or generated by open sources.⁴ Process-generated precipitant dust comes from industrial activities where the actual structure of the material is altered, such as a rock crushing operation.⁴ Open sources generate precipitant dust as a result of the wind or mechanical contact. Examples of open source dust generation would be the movement of raw material, product, or waste, related to industrial activities. Some non-industrial sources include unpaved parking lots and roads, highways, “heavy construction activities”⁴ and “agricultural tilling”⁴.

Fugitive dust sources can be process or open source generated, but excludes dust emitted from stacks. Dust emitted from stacks is usually constant all year round with wind and rainfall not affecting the amount of dust emitted from the stack.

There are a wide variety of fugitive dust sources in the Western Cape of South Africa, namely:

- ploughing on farm lands,
- dust blown from recently ploughed fields,
- traffic on dirt roads,
- blasting at opencast mine operations,
- dust emitted from process buildings (excluding stacks),
- dust blown from stockpiles of raw and finished materials,
- crushing operations, and
- transportation of raw materials and products by rail or road.

The seasonal rainfall variation in different areas has a significant effect on the precipitant dust levels. This is shown by the high precipitant dust levels during winter in South Korea¹⁸ compared to the very low precipitant dust levels in the Western Cape of South Africa during winter.

In some studies there have been no statistical seasonal variations noted in the precipitant dust amounts.¹⁹

Precipitant dust levels in the Western Cape do not follow the same pattern as the precipitant dust levels in the summer rainfall areas of South Africa. The very dry summer conditions in the Western Cape can generate very high levels of precipitant dust.

1.5 Precipitant Dust Measurements and Standards

With the varied and numerous industrial and mining operations in the Western Cape, it is important to be able to identify the main source of precipitant dust in an area, especially if industrial or mining operations are in close proximity to one another.

Precipitant dust levels have been used as a continuous improvement indicator for mining and industrial concerns in the Western Cape. The regular reports on the precipitant dust levels to the mining and industrial concerns, not only quantify their precipitant dust levels for the period in question, but the reports also maintain awareness with regard to dust sources, and as such enable the fugitive dust sources to be identified.

The chemical constituents of the precipitant dust can also be revealing, especially when the chemical composition is significantly different to the chemical composition of the soil in the area or when a trace element can be identified as coming from a particular dust source in the area.

The measurement of precipitant dust in Australia is the “least commonly used” method for determining dust concentrations. Currently, there is no method to convert precipitant dust levels to Total Suspended Particulate (TSP) levels or PM₁₀ levels.¹¹

The United States of America does not have any air quality standards for particulate matter larger than a d50 of 10 micron (PM₁₀).¹⁶

The fall-out dust standards from STANDARDS SOUTH AFRICA (SANS)²⁰ are shown in Table 2.

Table 2: Dustfall standards SANS (2005)

Classification	Dustfall ($\text{mg m}^{-2} \text{d}^{-1}$) – averaged over 30 days.	Permitted frequency of exceeding the levels.
Target – long-term average	300	Long-term average (Annual)
Action – residential	600	Three within any year, no two sequential months.
Action – industrial	1200	Three within any year, no two sequential months.
Alert threshold	2400	None. First time exceeded, triggers remediation and reporting to authorities.

The largest proportion of dust particles generated from surface mining activities is greater than 30 μm and these will normally deposit within 100m of the source.⁵ This does not include the dust emitted from kiln stacks and other heated processes as the dust emitted from these processes can contain a large proportion of particles less than 10 μm . The heat and exit velocity from stacks makes the dust more likely to travel further from the source.

The smaller the particles the further they can potentially travel.⁵

Large dust storms in arid areas can lift dust particles more than five kilometres up into the atmosphere and the dust can be “transported thousands of kilometres.”¹⁵

The deposition of particles can take place by three dominant routes: wet deposition, dry deposition, and occult deposition.¹⁶ Wet deposition includes rain and snow precipitation.¹⁶ Occult deposition is the deposition that occurs during mist and fog conditions.¹⁶

There is an interaction between dry deposition and wet deposition in that wet deposition often removes previously deposited dry precipitant dust on exposed surfaces.¹⁶ If the rainfall is very light then it may not be able to wash away the dry deposited material on surfaces and the content of the wet deposition may be added to the exposed surface when the rain stops.¹⁶

Dry deposition is a slow process compared to wet deposition, but dry deposition occurs almost continuously.^{16, 15}

Precipitant dust can be measured as wet deposition, dry deposition, or as total deposition (wet + dry). It is sometimes difficult to separate the wet and dry deposition from each other because occult deposition is sort of half way between wet and dry deposition. The monitoring of total precipitant dust is relevant as it provides an indication of the pollution amount from the atmosphere.²¹

Only insoluble precipitant dust measurements have been considered in this report. Both wet and dry depositions have been reported on in this report as one figure.

The atmosphere is continuously being gleaned of its dust load through the different deposition mechanisms described.²²

1.6 Export Bucket Definition and DustWatch Technology

The DustWatch unit has four buckets that face north, south, east, and west respectively. The export bucket is defined as the bucket that is in line with the industry or factory being monitored. The precipitant dust from the dust source is predominantly collected in the export bucket. The export bucket is also the bucket that is used for legislative compliance purposes, as this is the bucket that collects the dust being exported from the source towards the sensitive area.

The DustWatch units prevent the ground level dust from contaminating the precipitant dust sample by the specially-designed lid that covers the buckets. The lid prevents wind-blown dust from being collected when the wind speed is greater than about 3 m/s. The only way that ground level dust can be deposited into the bucket is if the wind is gusting at regular intervals, thus lifting dust into the air and into the buckets. Ground level wind-blown dust that is larger than 100 micron is not normally lifted to a height higher than two meters and a particle size analysis will be able to confirm if there is contamination from ground level dust.

The water in the buckets collect the dust.²³

1.7 General Comments and Study Objectives

In an area with lots of wind above 3m/s the DustWatch will collect less material than in an area with the same atmospheric dust load but with lower wind speeds. The DustWatch will, however, provide a representative sample of atmospheric dust load without contamination from ground-level sources.

In remote areas it is important to be able to monitor for precipitant dust without the need for electricity.²⁴ The other advantages of passive monitors are that they are noiseless, simple, robust, and lightweight.²⁵ It is also possible to have more passive monitoring stations in an area compared to active monitoring stations.²⁵

In order to fully describe background dust levels and site dust deposition patterns, long-term and detailed dust monitoring is required. Patterns of dust deposition, or of airborne dust, are extremely variable. In particular, dust patterns are often characterised by occasional dusting events comprising high levels of dust deposition largely caused by particular, and possibly infrequent, combinations of wind and rainfall conditions. At other times dust deposition from industrial sites may be low or insignificant, but a precipitant dust monitor is still subject to background and other long distance dust sources.²⁶

In conclusion, passive precipitant dust monitoring is an economical alternative to expensive active precipitant dust samplers. Because of the low cost, more sampling locations can be used in the monitoring programme. With the almost continuous monitoring of the precipitant dust levels, 365 days a year, passive precipitant dust monitoring is able to provide useful information pertaining to atmospheric dust loads, pollution and associated health risks. Samples are collected every two weeks with the only downtime being due to sample contamination or a mishap, and the time it takes to change the buckets. Hence this research report describes the precipitant dust levels around two enterprises in the Western Cape of South Africa, from October 2001 to May 2005.

The study objectives are:

1. to describe precipitant dust levels around two enterprises in the Western Cape from 2001 –2005
2. to describe the particle size distribution of the precipitant dust from a calcining industry in 2004
3. to determine trends in precipitant dust concentrations for the years 2001-2005

The remaining chapters are “Methods and Materials Used” which includes the study design, “Results”, “Discussion”, “Conclusions and Recommendations for Future Study”.

2 METHODS AND MATERIALS USED

This chapter presents the study design and provides a description of the two enterprises being monitored. This is followed by an explanation of the sample preparation method and the laboratory analysis used to obtain the precipitant dust data. Quality control and the statistical analysis performed on the precipitant dust data are also explained. Finally the ethical ramifications of this study are presented.

2.1 Study Design

The study is a retrospective review and analysis of more than 3600 precipitant dust measurements taken around two enterprises in the Western Cape of South Africa.

Five industries in the Western Cape where continuous precipitant dust sampling was being undertaken were approached for permission to use their data in the research report.

These industries broadly represented three geographical locations in the Western Cape. The method of precipitant dust collection was the same at all of the sites with the only difference being the number of sampling locations used to monitor the precipitant dust.

Only two of the five industries responded positively and only the data collected from these two industries were used in the research report.

Both of the industries that responded positively had collected precipitant dust data over the required study period selected for this report. The industries were in two different geographical locations in the Western Cape.

One additional site from the third geographical position would have enabled a more comprehensive coverage of the area to be described. Unfortunately this was not possible.

An environmental consulting company, Gerry Kuhn Environmental and Hygiene Engineering, positioned precipitant dust monitoring

units at strategic locations, taking process and open dust sources into account. With measurements having been taken every two weeks continuously throughout the year at various locations, both seasonal changes and long-term trends in the amount of precipitant dust were identified.

A total of ten dust monitoring locations were considered in this report with detailed statistical analysis done on the ten export buckets, one from each location. The export bucket is the bucket that is positioned most in line with the dust source and is the bucket that will theoretically collect most of the dust when the wind has blown over the source towards the sampling location.

2.2 Description of the Enterprises and Monitoring Positions

Precipitant dust measurements were taken in the Western Cape in the vicinity of two enterprises. The first enterprise was predominantly an opencast mine with a calcining process; there were eight precipitant dust monitors positioned around this site and in adjacent residential and farm areas, (see Figure 1). The second enterprise was a metal smelting operation and there were two sampling locations, one to the north and one to the south of the site (see Figure 2).

The data used in the research report is historical data and the paragraph below indicates the methods used to decide on the locations for the monitoring units. The precipitant dust monitor units were located carefully so as to collect data that was as representative as possible.^{27,14} The location of the units was determined by:

1. studying the area surrounding the enterprise to identify residential, farming, and other industrial areas
2. identifying dust sources on site
3. studying the local climate and topography

The naming of the directions north, south, east and west were idealistic and if the dust source was in a direction that was not exactly in line with the north, south, east, or west directions, then

the unit was positioned and labelled with one of the buckets directly in line with the dust source. The naming was still kept to north, south, east, and west.

The open cast mine with a calcining process, had the following potential dust sources: kiln stack with electrostatic precipitator for dust control; overburden dump; various smaller dumps; un-tarred haul roads; rock crushers; raw and product mills; conveyors; haul truck tipping areas; contractors on site working through the overburden dump; unpaved open areas.

The calcining industry was surrounded by predominantly wheat-farming areas with the nearest residential area 4.1km to the north. The RWD and KF sampling locations were the furthest apart in a west east direction, 4.7 km, while the 4SS and the QD sampling locations were the furthest apart in a north south direction, 6 km.

The distances to the nearest potential dust source for each of the sampling locations at the calcining industry are shown below (please use Figure 1 for direction determination):

- DHF – 310 meters from the large overburden dump site.
- GAT – 30 meters from the main entry and exit point for the trucks transporting the product.
- 4SS – 1.8 km from the old quarry that is no longer used. The area has not been fully rehabilitated.
- GCD – 550 meters from the main stack emission point.
- MD – 100 meters from the old quarry.
- RWD – 800 meters from the main stack emission point.
- QD – 500 meters from the quarry. The quarry is 1.4 km long and 400 meters wide.
- KF – 1.7 km from the large overburden dump site.

The smelting industry had the following potential dust sources: smelter building stack with periodic emissions and bag filter dust control; a coal stockpile; product silos; unpaved areas; vehicle traffic on unpaved areas.

The nearest residential area to the smelting industry was 8.4km to the north-west of the site. The SO and SG sampling locations were 850 meters apart and were positioned to the north and south of the smelting industry. The SO unit was 80 meters from the closest dust source, a coal stockpile and 310 meters away from the main stack emission point. The SG unit was 80 meters away from the closest dust source, an unpaved road and 590 meters from the stack emission point.

The main potential interferences with regard to precipitant dust were:

- A railway loading facility located to the north of the smelting industry – 860 meters away from the SO sampling location.
- A small coal processing plant to the north of the smelting industry with a stockpile, unpaved areas, and stack emissions – 670 meters away from the SO sampling location.
- A large steel manufacturing process to the south of the smelting industry with numerous precipitant dust emission sources – 1.8 km from the SG sampling location.
- A busy railway line used for transportation of material from the whole of the west coast to the harbour – 320 meters to the north west of the SG sampling location.
- The harbour – 5.8 km to the south west of the SG sampling location.





Figure 2: Positions of the two precipitant dust-monitoring positions at the smelting industry.

Note: SO and SG are the names of the sampling locations respectively and are not acronyms.

2.3 Sample Preparation Method and Laboratory Analysis

Precipitant dust was collected by having open top buckets exposed to the atmosphere for a period of 14 days at a time. The sampling extended over three to four years. The particulate in the atmosphere fell passively into the buckets and was then weighed to report a result as milligrams per square meter per day ($\text{mg m}^{-2} \text{d}^{-1}$). Liquid was maintained in the bucket for the duration of the measurement period to prevent re-entrainment of the dust already collected.

Precipitant dust results were collected every two weeks on a continuous basis using the DustWatch precipitant dust monitor and the American Standard Test Method¹² ASTM 1982 “Standard Method for Collection and Analysis for Dust Fall”¹².

The precipitant dust was collected at each monitoring position in four buckets that were named north, south, east, and west.

The detailed method used is provided in APPENDIX A with a brief description of the method outlined below: ¹³

- The buckets were prepared by charging them with variable amounts of water, taking the expected evaporation that was likely to occur into account.
- A small amount of bleach was added to each bucket to prevent algae growth. The amount of bleach was varied depending on the climatic conditions prevailing.
- The buckets were then transported to site and put into the cradle of the DustWatch monitor and left in position for two weeks.
- As the wind changed direction, so the opening in the lid of the DustWatch unit moved over different buckets, thus allowing the directional monitoring of precipitant dust.
- After two weeks the buckets were collected and replaced with a new set of buckets. This ensured a continuous monitoring programme.

- 47mm filters were pre-weighed in the laboratory.
- The contents of each bucket were filtered through the pre-weighed filters using a Buchner Funnel arrangement as shown in APPENDIX B. Care was taken to ensure that no dust was left in the buckets.
- Once the solid contents of the bucket were collected on the filter, it was left to dry in the open for a minimum of 24 hours.
- When the filters were dry, they were weighed and the masses were recorded with the initial masses of the filters.
- The initial and final mass of the filter paper was then processed using a spreadsheet to yield a result in $\text{mg m}^{-2} \text{d}^{-1}$ for each bucket.

The water filter used to provide clean water for the buckets was an RCT water oxidation/reduction process filter.²⁸

The buckets used for the analysis were protected by the Bocan Patent A98/0298, and were supplied by Burcap Plastics. This patent is for the rim of the container, the part that is folded into the container. This feature creates a double seal when the lid is put on the container to prevent fluid from leaking. The height of the polypropylene bucket was 237.0mm and the inside diameter of the lip was 175.0mm. The diameter used as the collection area was the outside diameter, 179.8mm.

The filters used to collect the insoluble dust were made by Schleicher & Schuel, 1506 quantitative hard filter paper medium fast, retention $4\mu\text{m}$; thickness 0.15mm; weight 63 g/m^2 , classification DIN 53 135-2b, diameter 47mm.

2.4 Quality Control

Ten five litre buckets were each filled with four litres of water and five millilitres of bleach. The buckets were then filtered in the laboratory to determine the amount of dust in the purified water. The forty litres of water were filtered through one filter and yielded

a mass of 1.82mg. This equated to 0.182mg per bucket and over a two-week period this equated to $0.478 \text{ mg m}^{-2} \text{ d}^{-1}$.

Indeterminate errors are present in most experimental measurements and the potential sources of indeterminate errors for the DustWatch precipitant dust monitoring process are shown below:

- Bucket preparation – If too much bleach was added to the water then the excess bleach would come out of solution and form a solid material that would be collected on the filter – Positive error
- Bucket cleaning. Residual dust left in bucket between times that it was used – Positive error
- Bucket being emptied – When the water and dust was being put into the Buchner funnel¹² to be filtered. Any dust that remained in the bucket was not measured – Negative error
- During changing of buckets – Negative error if old bucket water was spilt accidentally, or a positive error if dust was allowed to enter either the old or new buckets.
- During the filtering process – Spillages from the buckets would result in loss of sample – Negative error
- If algae grew in the buckets – Either because too little bleach was put into the bucket or because of unusual weather conditions, such as excessive rain that diluted the bleach to a point where it was not able to prevent the formation of algae. The acidity of the rainfall also affects the formation of algae – Positive error
- During the filtering process – The sieves used to keep insects from being added to the precipitant dust samples have approximate apertures of 1mm^2 and any dust that adhered to the insects was not collected on the filter. Similarly any dust on the insect when it entered the bucket could also be added to

the mass of precipitant dust collected – Positive or negative error

The following procedure was used to limit the error in the precipitant dust monitoring results:

- The buckets were prepared indoors to prevent dust landing in the buckets while open. The system in place minimised the amount of time that the buckets were left open, i.e. the lids were put onto the buckets as soon as they had been prepared.
- The lids remained on the buckets from when they were prepared until they were ready to be put into the DustWatch unit.
- The buckets were kept upright during transportation.
- The buckets were changed one at a time with the system ensuring that the buckets were open for as little time as possible. Care was taken to not kick dust into the buckets or to have open buckets while working on the DustWatch unit.
- Buckets were kept closed until they were ready to be processed in the laboratory. The lids were kept loosely on the buckets while they waited in the queue to be processed.
- The washout water used to wash the buckets out into the Buchner funnel was also taken from the filtered source.
- The inside walls of the buckets were cleaned using a spatula and a squirt bottle. Rubber gloves were worn to limit the skin contact with the slightly acidic water in the buckets.
- After buckets were used in the field and the contents filtered, they were cleaned with soap and water and left to drip-dry before being prepared to go into the field again.

The quality control system in the wet and dry laboratories used for the analysis of the precipitant dust was able to identify unusually

high results and ensured that the results were within expected ranges.

Data was entered into the database every two weeks with written reports and updated graphs being generated every 28 days. Quality control for the database entries is done when the reports and updated graphs are being prepared. The database automatically identifies unusually high results, errors in dates, and unusually long periods where data has not been available every two weeks.

The absolute maximum error due to the actual time of day when the buckets were changed is 7.14 percent (over a 24 hour period). As the buckets were only changed during the daytime, the error is halved to 3.57 percent. Realistically the buckets were changed in the working daytime hours from 08h00 to 16h00 and this further decreases the error to 2.38 percent. This percentage equates to $28 \text{ mg m}^{-2} \text{ d}^{-1}$ as a percentage of $1200 \text{ mg m}^{-2} \text{ d}^{-1}$, and this is normally not going to alter the conclusions in the monthly reports. Due to the continuous sampling, the error in one cycle is cancelled out by the other cycles, resulting in the monthly, three monthly, and yearly averages being unaffected by the exact time of the day that the buckets were changed. The error decreases as the time period increases.

2.5 Particle Size Analysis

Four samples for particle size analysis were selected to cover all four of the directions around the calcining industry, one to the north, south, east, and west respectively. The full year's data for 2004 for the export buckets at the four monitoring positions was used for the analysis.

The precipitant dust coming from the calcining industry is predominantly collected in the export buckets and the size analysis of the sample collected in the export buckets would be the most representative of the precipitant dust coming from the calcining industry in the respective directions, north, south, east and west.

2.6 Data Handling and Analysis

Regarding the number of decimal points to include in the data, there was no value in reporting precipitant dust levels with any decimal figures as the difference between $678 \text{ mg m}^{-2} \text{ d}^{-1}$ and $678.8 \text{ mg m}^{-2} \text{ d}^{-1}$ did not provide any additional information about the data. There may even be a case for reporting precipitant dust levels rounded to the nearest ten i.e. 678 would be 680 and 673 would be 670 $\text{mg m}^{-2} \text{ d}^{-1}$. If alternative time units are used, then the case for using less significant figures is even stronger, e.g. if the time unit is altered to $\text{mg/m}^2/\text{month}$.

The Western Cape of South Africa is a winter rainfall area with most of the annual rainfall being in the months April to September each year.²⁹ Based on the climatic conditions in the Western Cape, two distinct periods were chosen from October to March and from April to September.

The term “warm dry period” has been used to describe the months from October to March and term “cold wet period” has been used to describe the months from April to September.

The export bucket from each monitoring position was selected for detailed statistical analysis. For the smelting industry, the south bucket at the SO sampling location, and the north bucket at the SG sampling location were selected. For the calcining industry, the south bucket at the 4SS sampling location, the north bucket at the GAT sampling location, the south bucket at the DHF sampling location, the west bucket at the KF sampling location, the north bucket at the QD sampling location, the south bucket at the GCD sampling location, the south bucket at the MD sampling location, and the east bucket at the RWD were selected.

The following was done to achieve the research objectives:

1. Descriptive statistical analysis on the whole data set, warm-dry and cold-wet periods combined. Additional descriptive statistical analysis on the individual warm-dry and cold-wet period data. The distribution of some of the data is presented

in box and whisker plots and no outliers were excluded from the plots.

2. Particle size analysis was done on four export bucket precipitant dust samples from the calcining industry. A total of 26 samples were composited to make up each annual sample.

M & L Inspectorate in Johannesburg South Africa, an accredited laboratory, undertook the analysis using a Malvern particle size analyser. The size range used was from 0.020 to 2000 micron with 102 measurements at different size intervals being taken. The laboratory followed standard procedures to ensure that the sample was well mixed and representative before doing the particle size analysis.

3. Bar graphs showing the total export bucket precipitant dust concentration at each monitoring position, for each warm-dry period from October 2001 to March 2005. The units $\text{g/m}^2/\text{warm-dry period}$ were used. The calculation took the average $\text{mg m}^{-2} \text{d}^{-1}$ value for the warm-dry period and divided it by 1000 to get grams and multiplied it by 182 days (or less if some data was missing) to get $\text{g/m}^2/\text{warm-dry period}$. The units of this number are not important as the bar graph is used to show a decreasing or increasing trend.
4. Chi Square tests for linear trend have been done for the export buckets at each location for the warm-dry periods. Chi Square tests for linear trend have been done for the proportions above 600 and 1200 $\text{mg m}^{-2} \text{d}^{-1}$.

When one two-week cycle of data was not available due to a sample loss or other reasons, the data value assigned was zero, and this data point was used in the statistical analysis. Where more than a few consecutive samples in either the warm or cold periods were missing, the analysis for the respective period was not done.

When selecting the data for the warm and cold periods, any middle date within a cycle that fell within the specified dates was accepted as being part of that period.

2.7 Ethics

The chairman of the ethics committee provided a letter stating that this research report did not need ethics approval.

The preliminary data that was to be used in this research report has already been made available to the companies. These companies have already responded to the reported levels.

Company names will be kept anonymous and copies of the research project will be sent to both enterprises.

The data were already collected and no human subjects were required to wear equipment and no human subjects were required to be sampled.

3 RESULTS

This chapter begins with a presentation of the descriptive statistics for the two industries that were studied, followed by the particle size analysis done on four samples from the calcining industry. This is followed by the trend analysis of the precipitant dust data, and subsequent Chi Square analysis for linear trend results.

The precipitant dust data spanned a period from October 2001 to March 2005. The data were all “two-week” data with one value being obtained every two weeks. The data spanned four warm dry periods and three cold wet periods.

The area is a winter (cold-wet period) rainfall area.

At the smelting industry:

- The export bucket from the SG sampling location is the north bucket.
- The export bucket from the SO sampling location is the south bucket.

The data for each of the monitoring positions was quite extensive and not easy to read at first glance. The graphs for all of the data obtained from the two monitoring positions at the smelting industry are available in APPENDIX C.

At the calcining industry:

- The export bucket from the 4SS sampling location was the south bucket.
- The export bucket from the GAT sampling location was the north bucket.
- The export bucket from the DHF sampling location was the south bucket.
- The export bucket from the KF sampling location was the west bucket.

- The export bucket from the QD sampling location was the north bucket.
- The export bucket from the GCD sampling location was the south bucket.
- The export bucket from the MD sampling location was the south bucket.
- The export bucket from the RWD sampling location was the east bucket.

The graphs for all of the data from the eight monitoring positions at the calcining industry are available in APPENDIX D.

The GCD, MD, and RWD sampling locations were initially set up to monitor only two directions. The units were upgraded to monitor all four directions in June, August, and April 2003 respectively.

Below is the descriptive statistics of all four directions at each precipitant dust sampling location.

3.1 Descriptive Statistics for the Precipitant Dust Concentrations

The data is initially described as one data set, warm-dry and cold-wet periods combined. Then the data is split into warm-dry and cold wet periods for further analysis.

The warm-dry periods are the periods that yield higher precipitant dust levels and the dust levels in these warm-dry periods are more likely to be above the residential ($600 \text{ mg m}^{-2} \text{ d}^{-1}$) and industrial ($1200 \text{ mg m}^{-2} \text{ d}^{-1}$) action levels.

The fall-out dust standards in Table 2 should be used with the description of the results obtained to assist with interpretation.

In Table 3 the median is consistently lower than the mean, indicating that the total data set is skewed to the lower ranges.

The other point to note is the varying maximum readings obtained from the different buckets.

The industrial action level ($1200 \text{ mg m}^{-2} \text{ d}^{-1}$) is applicable at both of the sampling locations at the smelting industry. With the legislation aimed at preventing excessive precipitant dust levels in a year, any maximum results above the industrial action level are an indication that the area is dusty. Where the maximum results have not exceeded the industrial action level then the area can be considered to be acceptable.

None of the maximum results for the SG sampling location were above $1200 \text{ mg m}^{-2} \text{ d}^{-1}$. This is in contrast to the fact that all of the SO bucket maximum results were above the industrial action level, $1200 \text{ mg m}^{-2} \text{ d}^{-1}$. The SO sampling location can be considered as being dusty at some stage within the study period.

Table 3: Precipitant dust measurements ($\text{mg m}^{-2} \text{d}^{-1}$) over 2001 to 2005 for the smelting industry for each direction at both sampling locations. The highlighted rows are the export directions at each sampling location.

	Number of Measurements	Mean	Standard Deviation	Confidence Interval (+ and - of the mean)	Min	Max	First Quartile	Median	Third Quartile
North (SG)	95	265	174	36	56	871	141	222	323
South (SG)	95	343	223	45	65	1091	165	304	467
East (SG)	95	280	204	41	48	1157	137	222	362
West (SG)	95	268	202	41	53	1195	127	202	335
North (SO)	95	591	394	80	66	1681	285	487	872
South (SO)	95	614	412	84	107	1826	296	489	849
East (SO)	95	609	430	88	86	2124	275	507	833
West (SO)	95	565	367	75	81	1674	252	475	806

Similarly to Table 3, Table 4 again indicates that the median is consistently lower than the mean. The maximum precipitant dust levels at each sampling location and from each direction vary quite considerably.

The action level for the GAT, DHF, KF, QD, and MD sampling locations is $1200 \text{ mg m}^{-2} \text{ d}^{-1}$. The other three sampling locations, 4SS, GCD, and RWD, are subject to the residential action level of $600 \text{ mg m}^{-2} \text{ d}^{-1}$.

All four of the maximum results at the 4SS sampling location exceeded the residential action level of $600 \text{ mg m}^{-2} \text{ d}^{-1}$. The GAT maximum results were all below the industrial action level of $1200 \text{ mg m}^{-2} \text{ d}^{-1}$. The DHF maximum results were all well above the industrial action level ($1200 \text{ mg m}^{-2} \text{ d}^{-1}$) with all four buckets yielding third quartile results above the limit. The south, east, and west maximum results at the KF sampling location were all above the industrial action level of $1200 \text{ mg m}^{-2} \text{ d}^{-1}$. None of the maximum results at the QD sampling location were above the industrial action level. All four buckets at the GCD sampling location collected maximum results above the residential action level ($600 \text{ mg m}^{-2} \text{ d}^{-1}$) applicable at this sampling location and this indicates that the area is dusty. The south, east, and west buckets at the MD sampling location yielded maximum results above the industrial action level ($1200 \text{ mg m}^{-2} \text{ d}^{-1}$). All of the directions at the RWD sampling location yielded maximum results above the residential action level ($600 \text{ mg m}^{-2} \text{ d}^{-1}$) and this indicates that the area was dusty at some time in the study period.

Table 4: Precipitant dust measurements ($\text{mg m}^{-2} \text{d}^{-1}$) over 2001 to 2005 for the calcining industry for each direction at the different sampling locations. The highlighted rows are the export directions at each sampling location.

	Number of Measurements	Mean	Standard Deviation	Confidence Interval (+ and - of the mean)	Min	Max	First Quartile	Median	Third Quartile
North (4SS)	95	157	170	35	18	1128	55	102	184
South (4SS)	95	188	166	34	19	719	54	124	278
East (4SS)	95	132	139	28	17	712	44	79	149
West (4SS)	95	181	145	30	22	703	64	133	254
North (GAT)	95	257	182	37	54	961	125	215	334
South (GAT)	95	277	192	39	29	872	129	239	341
East (GAT)	95	245	179	37	40	846	109	196	313
West (GAT)	95	294	170	35	78	931	152	272	390
North (DHF)	80	917	733	163	84	3294	252	669	1397
South (DHF)	80	852	627	140	54	2306	292	640	1343
East (DHF)	80	981	820	183	67	3964	266	763	1647
West (DHF)	80	871	703	157	100	2867	261	532	1494
North (KF)	95	352	278	57	0	1051	140	274	517
South (KF)	95	459	382	78	0	1701	160	354	777
East (KF)	95	325	275	56	0	1244	120	248	509
West (KF)	95	496	427	87	0	1662	160	366	721
North (QD)	95	267	189	39	50	973	145	206	356
South (QD)	95	269	184	37	0	753	139	229	346
East (QD)	95	250	158	32	29	690	137	200	322
West (QD)	95	300	190	39	0	770	159	245	431
North (GCD)	95	223	200	41	12	1019	75	148	300

	Number of Measurements	Mean	Standard Deviation	Confidence Interval (+ and - of the mean)	Min	Max	First Quartile	Median	Third Quartile
South (GCD)	95	223	196	40	0	1008	66	154	337
East (GCD)	50	205	166	47	32	666	79	163	276
West (GCD)	50	202	171	49	29	722	74	128	283
North (MD)	88	285	215	46	0	946	93	225	415
South (MD)	88	371	411	87	0	2973	87	290	516
East (MD)	47	262	299	88	0	1680	93	162	353
West (MD)	47	362	331	97	0	1522	169	247	485
North (RWD)	55	209	155	42	29	693	94	169	297
South (RWD)	55	226	190	51	34	867	76	160	349
East (RWD)	96	251	213	43	34	1249	97	160	354
West (RWD)	96	245	199	40	3	925	86	186	357

The warm-dry and cold-wet data has been combined in Figure 3 and this confirms that the whole data set is skewed to the lower ranges. Figure 3 also shows how the precipitant dust levels vary considerably from one sampling location to the next.

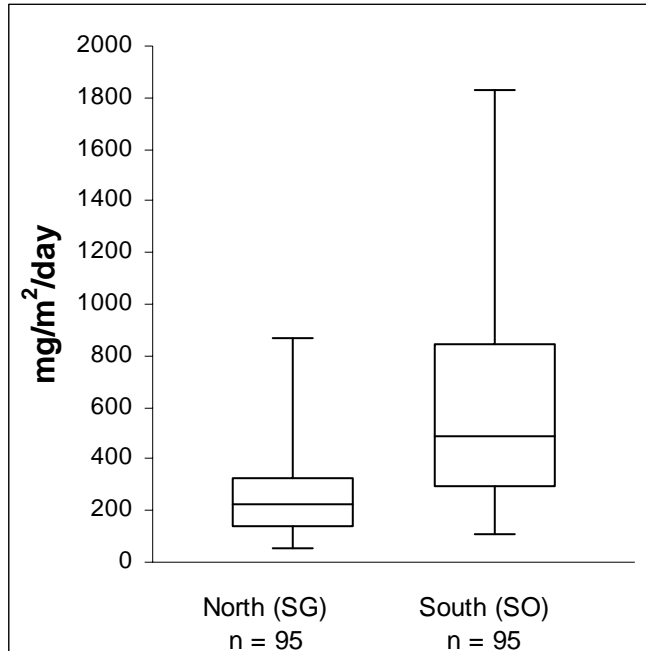

Figure 3: Distribution of precipitant dust for the north and south buckets of the SG and SO sampling locations for 2001 to 2005. Warm-dry and cold-wet measurements are combined.

Note: n = the number of samples

Only the export buckets have been shown in Figure 3 but all of the bucket directions yielded similarly skewed data with varying quantities being collected from each direction.

The high maximum result from the south bucket of the SO sampling location is again indicated in Figure 3.

Only the export buckets of four of the eight calcining sampling locations are shown in Figure 4. These are the same export buckets that were sent for particle size analysis.

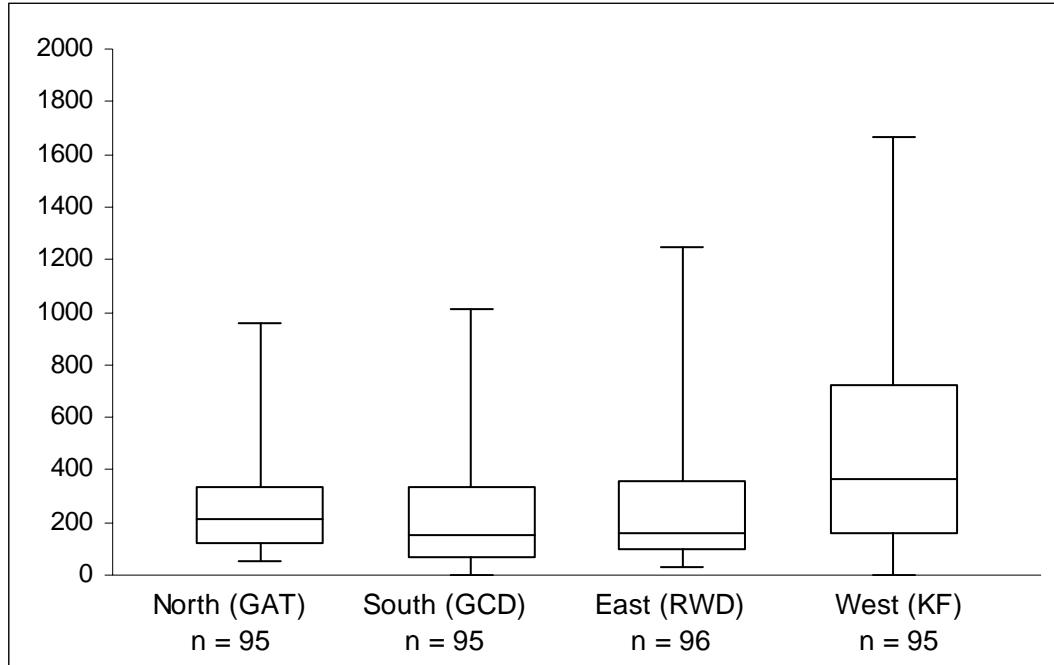

Figure 4: Distribution of precipitant dust ($\text{mg m}^{-2} \text{d}^{-1}$) for the north, south, east, and west buckets of the GAT, GCD, RWD, and KF sampling locations for 2001 to 2005. Warm-dry and cold-wet measurements are combined.

Note: n = the number of samples

Figure 4 shows that the data from these four export buckets were skewed to the lower ranges.

Figure 4 also shows that the maximum value of the export bucket at the GCD, and RWD sampling locations exceeded the residential action level of $600 \text{ mg m}^{-2} \text{d}^{-1}$. At the KF sampling location, the industrial action level of $1200 \text{ mg m}^{-2} \text{d}^{-1}$ was exceeded.

Table 5 describes only the export bucket data for the smelting industry sampling locations, split into warm-dry and cold-wet data sets.

Table 5: Precipitant dust measurements ($\text{mg m}^{-2} \text{d}^{-1}$) over 2001 to 2005 for the smelting industry for each export bucket at the sampling locations of the smelting industry in the warm-dry period and the cold-wet period.

	Number of Measurements	Mean	Standard Deviation	Confidence Interval (+ and - of the mean)	Min	Max	First Quartile	Median	Third Quartile
North (SG) – Warm period	52	316	201	56	56	871	165	244	432
North (SG) - Cold Period	43	202	109	34	62	592	110	203	265
South (SO) – Warm period	52	802	423	118	206	1826	453	740	1089
South (SO) - Cold Period	43	387	256	79	107	1279	211	321	473

The warm-dry data set is still skewed to the lower ranges at both of the monitoring positions.

Of note is the very similar median and mean for the cold-wet data set for the north bucket of the SG sampling location.

The warm-dry period data is consistently higher than the cold-wet period data.

Interestingly, the maximum result of the export bucket at the SO monitoring location was above the industrial action level of $1200 \text{ mg m}^{-2} \text{ d}^{-1}$, even during the cold-wet period.

Table 6 shows that the warm-dry and cold-wet data sets are still skewed to the lower ranges at the export buckets of the calcining industry sampling locations because all of the medians are lower than the means.

The warm-dry period data is consistently higher than the cold-wet period data.

Looking at the maximum results of the export bucket in the warm-dry and cold-wet periods individually, the 4SS sampling location only exceeded the residential action level of $600 \text{ mg m}^{-2} \text{ d}^{-1}$ in the warm-dry period. The DHF and KF sampling locations also only exceeded the industrial action level of $1200 \text{ mg m}^{-2} \text{ d}^{-1}$ in the warm-dry period. The maximum results at the GCD sampling location also only exceeded the residential action level of $600 \text{ mg m}^{-2} \text{ d}^{-1}$ in the warm-dry period. The MD sampling location yielded maximum results above the industrial action level of $1200 \text{ mg m}^{-2} \text{ d}^{-1}$ in the warm-dry period, the cold-wet period data yielded a maximum result well below the action level.

The data for the warm-dry and cold-wet periods are skewed to the lower ranges with precipitant dust levels varying at each sampling location.

Table 6: Precipitant dust measurements ($\text{mg m}^{-2} \text{d}^{-1}$) over 2001 to 2005 for the calcining industry for each export bucket at the sampling locations of the calcining industry in the warm-dry period and the cold-wet period.

	Number of Measurements	Mean	Standard Deviation	Confidence Interval (+ and - of the mean)	Min	Max	First Quartile	Median	Third Quartile
South (4SS) - Warm Period	52	259	174	48	42	719	112	220	385
South (4SS) - Cold Period	43	102	106	33	19	567	36	67	122
North (GAT) - Warm Period	52	307	212	59	66	961	148	237	420
North (GAT) - Cold Period	43	197	115	35	54	483	100	179	250
South (DHF) - Warm Period	39	1383	450	146	531	2306	1050	1355	1691
South (DHF) - Cold Period	41	347	216	68	54	1121	219	292	424
West (KF) - Warm Period	40	849	385	123	142	1662	555	835	1148
West (KF) - Cold Period	43	307	214	66	77	833	160	198	441
North (QD) - Warm Period	52	301	207	57	50	973	157	229	414
North (QD) - Cold Period	43	224	158	49	55	870	122	175	301
South (GCD) - Warm Period	52	297	215	60	32	1008	130	281	437

	Number of Measurements	Mean	Standard Deviation	Confidence Interval (+ and - of the mean)	Min	Max	First Quartile	Median	Third Quartile
South (GCD) - Cold Period	43	134	123	38	0	579	55	84	176
South (MD) - Warm Period	53	506	471	130	0	2973	237	397	644
South (MD) - Cold Period	35	167	152	52	0	596	71	102	266
East (RWD) - Warm Period	53	293	206	57	43	792	144	236	387
East (RWD) - Cold Period	43	200	213	66	34	1249	68	138	279

The export bucket, warm-dry period precipitant results at the SO sampling location are higher than at the SG sampling location as shown in Figure 5. The SO monitoring area is dusty. The interquartile range for the SO and SG sampling locations do not overlap in the warm-dry period.

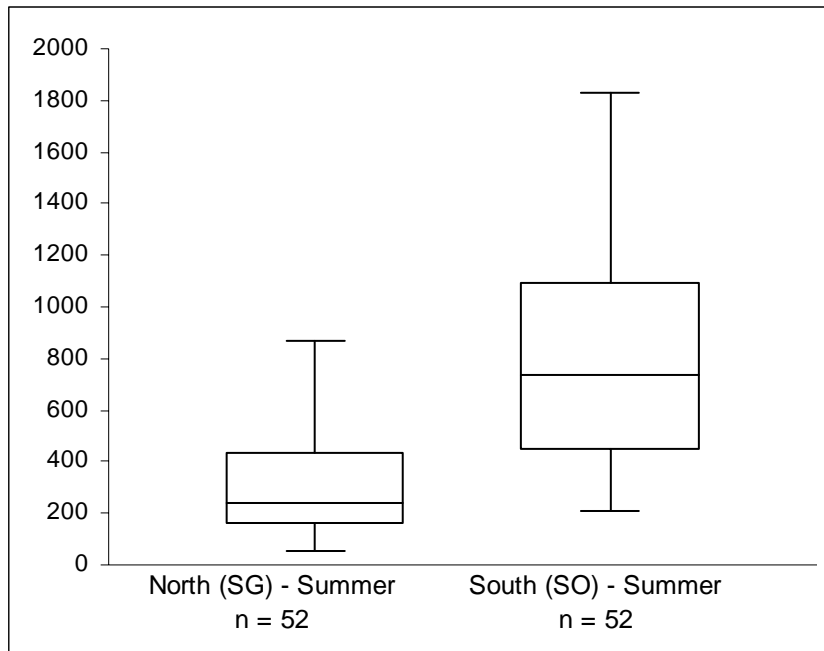

Figure 5: Distribution of warm-dry precipitant dust ($\text{mg m}^{-2} \text{d}^{-1}$) for the north and south buckets of the SG and SO sampling locations for 2001 to 2005.

Note: n = the number of samples and summer = warm dry period

In the cold-wet period the export bucket results at the SO sampling location are still higher than the SG sampling location results, but the interquartile ranges do overlap as shown in Figure 6.

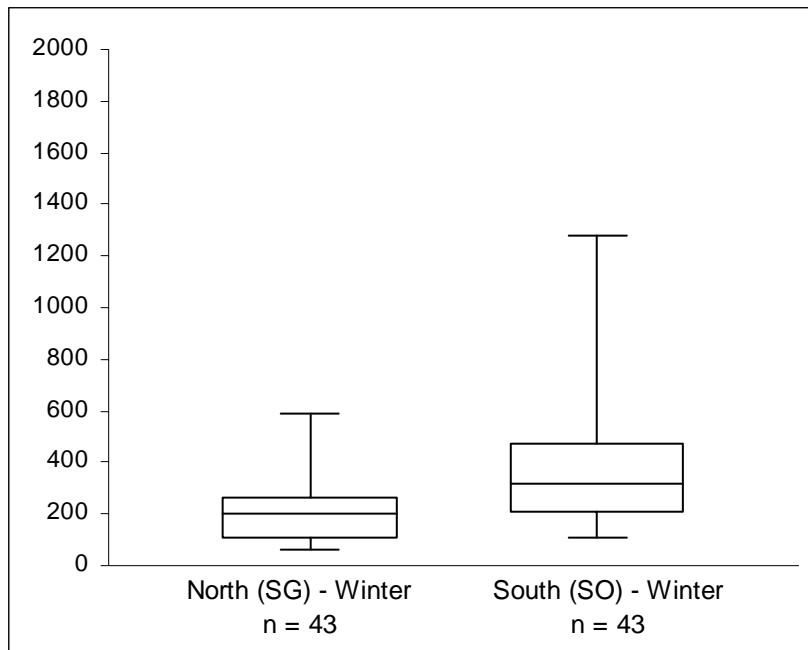

Figure 6: Distribution of cold-wet precipitant dust ($\text{mg m}^{-2} \text{d}^{-1}$) for the north and south buckets of the SG and SO sampling locations for 2001 to 2005.

Note: n = the number of samples and winter = cold wet period

The export bucket warm-dry period data for the GAT, GCD, RWD and KF sampling locations shown in Figure 7 indicate that the interquartile range for the KF location is well above the interquartile ranges of the other sampling locations. It is important also to remember that the lower residential action level of $600 \text{ mg m}^{-2} \text{d}^{-1}$ is applicable to the GCD and RWD sampling locations.

In the cold-wet periods, all the interquartile ranges overlap with the RWD maximum results being higher than the maximum results from the KF sampling location.

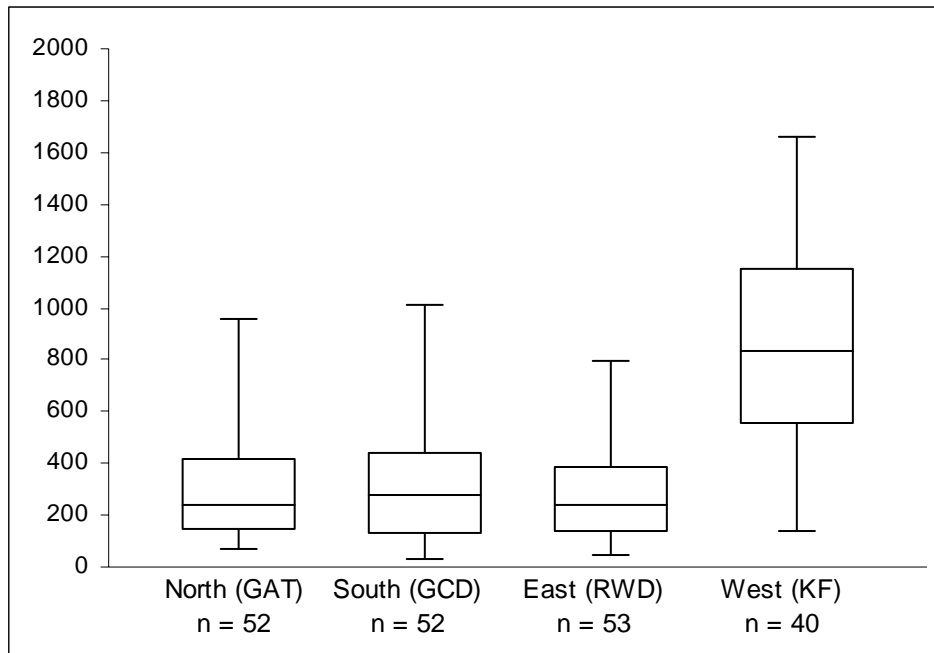

Figure 7: Distribution of warm-dry precipitant dust ($\text{mg m}^{-2} \text{d}^{-1}$) for the north, south, east, and west buckets of the GAT, GCD, RWD, and KF sampling locations for 2001 to 2005.

Note: n = the number of samples

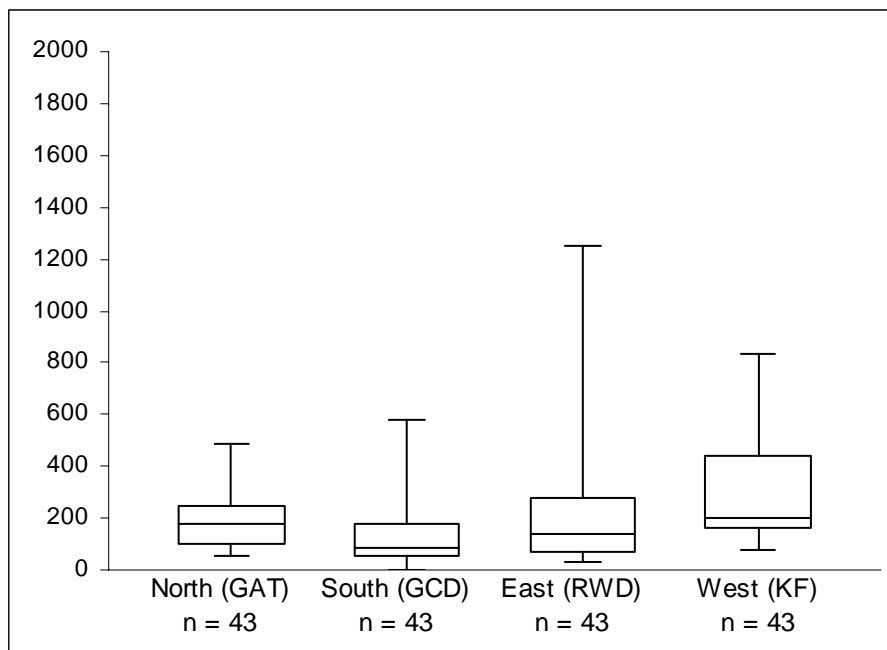

Figure 8: Distribution of cold-wet precipitant dust ($\text{mg m}^{-2} \text{d}^{-1}$) for the north, south, east, and west buckets of the GAT, GCD, RWD, and KF sampling locations for 2001 to 2005.

Note: n = the number of samples

The limits applicable to the sampling locations depend on the location and the proximity to a residential area. The residential action level is $600 \text{ mg m}^{-2} \text{ d}^{-1}$ and the industrial action level is $1200 \text{ mg m}^{-2} \text{ d}^{-1}$. Table 7, Table 8, and Table 9 indicate the proportions of the export bucket, warm-dry period data set, that are above 600 and $1200 \text{ mg m}^{-2} \text{ d}^{-1}$. The information from Table 7, Table 8, and Table 9 describes the precipitant dust concentrations in relation to the residential ($600 \text{ mg m}^{-2} \text{ d}^{-1}$) and industrial ($1200 \text{ mg m}^{-2} \text{ d}^{-1}$) action levels in each warm-dry period.

The information in Table 7, Table 8, and Table 9 will be used for the Chi Square test for trend analysis.

The SO monitoring area was very dusty in the first two warm periods with the 2003/2004 and 2004/2005 warm-dry periods being a lot less dusty.

Table 7: Number and percentages of warm-dry precipitant dust measurements above $600 \text{ mg m}^{-2} \text{ d}^{-1}$ and above $1200 \text{ mg m}^{-2} \text{ d}^{-1}$ by year for the export bucket at each sampling location of the smelting industry. The total number of measurements for each year is 13 for the warm dry period and 13 for the cold-wet period.

Warm-dry Period	SG Sampling Location		SO Sampling Location	
	Number above $600 \text{ mg m}^{-2} \text{ d}^{-1}$	Number above $1200 \text{ mg m}^{-2} \text{ d}^{-1}$	Number above $600 \text{ mg m}^{-2} \text{ d}^{-1}$	Number above $1200 \text{ mg m}^{-2} \text{ d}^{-1}$
2001/2002 summer - North	3 (23%)	0 (0%)	13 (100%)	5 (38%)
2002/2003 summer - North	3 (23%)	0 (0%)	10 (77%)	4 (31%)
2003/2004 summer - North	1 (8%)	0 (0%)	6 (46%)	1 (8%)
2004/2005 summer - North	0 (0%)	0 (0%)	5 (38%)	0 (0%)

Table 8: Number and percentages of warm-dry precipitant dust measurements above 600 mg m⁻² d⁻¹ and above 1200 mg m⁻² d⁻¹ by year for the export bucket at the 4SS, GAT, DHF, and KF sampling locations of the calcining industry. The total number of measurements for each year is 13 for the warm dry period and 13 for the cold-wet period.

Warm-dry Period	4SS Sampling Location		GAT Sampling Location		DHF Sampling Location		KF Sampling Location	
	Number above 600	Number above 1200	Number above 600	Number above 1200	Number above 600	Number above 1200	Number above 600	Number above 1200
2001/2002 summer - North	1 (8%)	0 (0%)	2 (15%)	0 (0%)	No results in this period	No results in this period	9 (69%)	3 (23%)
2002/2003 summer - North	1 (8%)	0 (0%)	1 (8%)	0 (0%)	12 (92%)	6 (46%)	No results in this period	No results in this period
2003/2004 summer - North	0 (0%)	0 (0%)	2 (15%)	0 (0%)	13 (100%)	11 (85%)	10 (77%)	6 (46%)
2004/2005 summer - North	0 (0%)	0 (0%)	0 (0%)	0 (0%)	13 (100%)	9 (69%)	8 (62%)	0 (0%)

The DHF sampling location did not yield any results in the first warm-dry period, (October 2001 to March 2002) because the unit only started monitoring April 2002. The KF sampling location did not yield any results in the second warm-dry period (October 2002 to March 2003) because too many two-week cycles of data were not available. The KF sampling location did not operate properly during the period and had to undergo maintenance.

The areas near the 4SS and KF sampling locations were dusty at some stage during the study period with results above the applicable action level but both of the export buckets at these sampling locations did not exceed the action level in the latest warm-dry period (2004/2005).

The export bucket at the DHF sampling location exceeded the industrial action level of $1200 \text{ mg m}^{-2} \text{ d}^{-1}$ in all of the warm-dry periods and this area is dusty.

Table 9: Number and percentages of warm-dry precipitant dust measurements above 600 mg m⁻² d⁻¹ and above 1200 mg m⁻² d⁻¹ by year for the export bucket at each of the sampling locations of the calcining industry. The total number of measurements for each year is 13 for the warm dry period and 13 for the cold-wet period.

Note: * total number of measurements = 14

	QD Sampling Location		GCD Sampling Location		MD Sampling Location		RWD Sampling Location	
	Number above 600	Number above 1200	Number above 600	Number above 1200	Number above 600	Number above 1200)	Number above 600	Number above 1200
2001/2002 summer - North	2 (15%)	0 (0%)	2 (15%)	0 (0%)	5 (38%)	0 (0%)	2 (15%)	0 (0%)
2002/2003 summer - North	0 (0%)	0 (0%)	1 (8%)	0 (0%)	6 (43%)	1 (7%) *	2 (14%) *	0 (0%)
2003/2004 summer - North	1 (8%)	0 (0%)	0 (0%)	0 (0%)	3 (23%)	1 (8%)	1 (8%)	0 (0%)
2004/2005 summer - North	1 (8%)	0 (0%)	0 (0%)	0 (0%)	3 (23%)	0 (0%)	1 (8%)	0 (0%)

The export bucket results at the GCD and the MD sampling locations exceeded the applicable action level during the study period but did not exceed the action level in the last warm-dry period. The RWD sampling location was the only other location, along with the DHF sampling location, that exceeded the action level in the most recent 2004/2005 warm-dry period.

3.2 Particle Size Analysis of Four Precipitant Dust Samples from the Calcining Industry.

Four export bucket samples from the calcining industry were sent for analysis. None of the smelting industry samples were sent for analysis because the consistency of the analysis results from the calcining process was good enough to explore the research objective with regard to particle size.

Things to note from the particle size analysis results are:

1. The GAT, GCD, and RWD sampling locations yielded very similar particle size analysis results (log-normally distributed) with particulate being predominantly less than 100 μm . The KF particle size distribution was different and skewed towards particles larger than 100 μm . The agricultural activities in the vicinity of this sampling location are the most likely source of these large particles.
2. The amount of smaller particles, less than 15 μm in all of the particles size analysis results. These small particles are within the PM_{10} range and this indicates that fallout dust monitoring does collect particles in the PM_{10} size fraction. The PM_{10} fraction is about 22 percent by volume for the GAT, GCD, and RWD sampling locations and about eleven percent by volume for the KF sampling location. The inundation of the KF sampling location with particles larger than 100 μm have affected the volume percent of PM_{10} particulate collected.

3. The diameter of maximum concentration in Figure 9, through to Figure 11 , 35, 30 and 40 micron respectively.
4. The existence of two other smaller distributions in Figure 9, through to Figure 11, one with a median of about 1 micron and the other with a median of about 400 micron.
5. The existence of two overlapping log-normally distributions in Figure 12, one with a maximum concentration diameter of 100 micron, and the other with a maximum concentration diameter of about 400 micron.
6. The percentage of particles below 40 μm , as these particles can enter the nasal passage^{9,10}. The percentage of particles by volume, below 40 μm is just above sixty percent for the GAT, GCD, and RWD particle size distributions.

Figure 9 through to Figure 12 show the particle size analysis graphs for the, GAT north bucket, GCD south bucket, RWD east bucket and the KF west bucket respectively.



Result Analysis Report

Sample Name: SOP Name: Measured: 14 October 2005 11:48:34 AM
Filter A72020 Analysed: 14 October 2005 11:48:35 AM
Sample Source & type: Measured by: Theo
 Supplier = Inspectorate M&L
Sample bulk lot ref: SDS479

Particle Name: Accessory Name: Size range: 0.020 to 2000.000 um **Obscuration:** 31.06 %
 Default Hydro 2000MU (A)
Particle RI: 1.520 **Absorption:** 0.1 **Weighted Residual:** 0.557 % **Result Emulation:** Off
Dispersant: Water **Dispersant RI:** 1.330

Span 2.621 Surface Weighted Mean 11.136 um **Vol. Weighted Mean D[4,3]:** 53.717 um **Result units:** Volume
d(0.1): 7.197 um **d(0.5):** 32.041 um **d(0.9):** 91.176 um

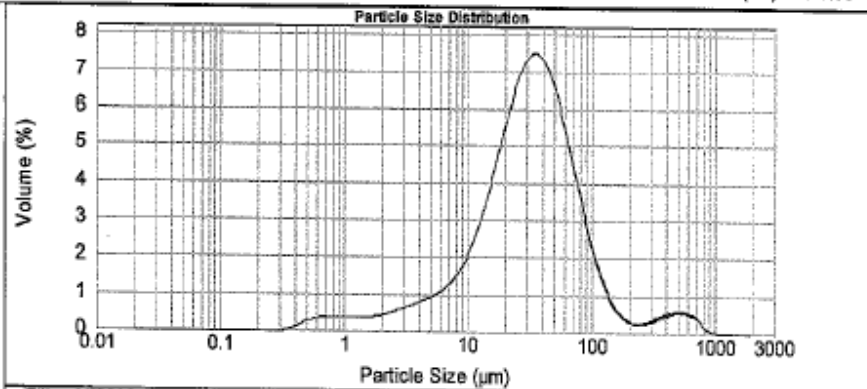

— Filter A72020, 14 October 2005 11:48:10 AM — Filter A72020, 14 October 2005 11:48:34 AM

Size (µm)	Vol Under %	Size (µm)	Vol Under %	Size (µm)	Vol Under %	Size (µm)	Vol Under %	Size (µm)	Vol Under %	Size (µm)	Vol Under %
0.020	0.00	0.142	0.00	1.002	1.91	7.695	9.88	50.238	71.28	355.656	97.49
0.022	0.00	0.159	0.00	1.125	2.18	7.962	10.90	56.368	79.01	399.052	97.79
0.025	0.00	0.178	0.00	1.282	2.45	8.634	12.09	63.246	80.25	447.744	98.15
0.028	0.00	0.200	0.00	1.416	2.71	10.024	13.48	70.963	83.93	502.377	98.55
0.032	0.00	0.224	0.00	1.589	2.97	11.247	15.17	79.621	87.65	563.677	98.95
0.036	0.00	0.252	0.00	1.785	3.25	12.619	17.17	89.337	89.60	632.458	99.34
0.040	0.00	0.283	0.00	2.000	3.55	14.199	19.58	100.237	91.64	709.627	99.67
0.045	0.00	0.317	0.00	2.244	3.90	15.887	22.44	112.468	93.21	796.214	99.90
0.050	0.00	0.355	0.00	2.518	4.27	17.825	25.78	126.191	94.38	893.367	99.98
0.056	0.00	0.399	0.05	2.826	4.69	20.000	29.64	141.589	95.22	1002.374	100.00
0.063	0.00	0.448	0.14	3.170	5.15	22.440	34.00	158.868	95.80	1124.683	100.00
0.071	0.00	0.502	0.32	3.557	5.66	25.179	38.82	178.250	96.20	1261.915	100.00
0.080	0.00	0.564	0.53	3.991	6.21	28.251	44.01	200.000	96.47	1416.682	100.00
0.089	0.00	0.632	0.78	4.477	6.82	31.696	49.46	224.404	96.67	1588.656	100.00
0.100	0.00	0.710	1.06	5.024	7.47	35.550	55.09	251.785	96.84	1782.502	100.00
0.112	0.00	0.798	1.35	5.637	8.19	39.995	60.89	282.508	97.02	2000.000	100.00
0.126	0.00	0.893	1.63	6.325	8.99	44.774	66.13	316.879	97.23		

Operator notes: Pumped @ 2000rpm
 Us externally

Figure 9: Particle size analysis of the north bucket at the GAT sampling location.



Result Analysis Report

Sample Name: SOP Name: Measured: 14 October 2005 09:18:05 AM
 Filter A72017 Analysed: 14 October 2005 09:18:06 AM
Sample Source & type: Measured by: Theo
 Supplier = Inspectorate M&L
Sample bulk lot ref: SDS482

Particle Name: Accessory Name: Size range: 0.020 to 2000.000 um Obscuration: 19.61 %
 Default Hydro 2000MU (A)
Particle RI: 1.520 **Absorption:** 0.1 **Weighted Residual:** 1.424 % **Result Emulation:** Off

Dispersant Water **Dispersant RI:** 1.330

Span 3.307 Surface Weighted Mean 12.247 um **Vol. Weighted Mean D[4,3]:** 57.074 um **Result units:** Volume

d(0.1): 7.739 um **d(0.5):** 30.768 um **d(0.9):** 109.502 um

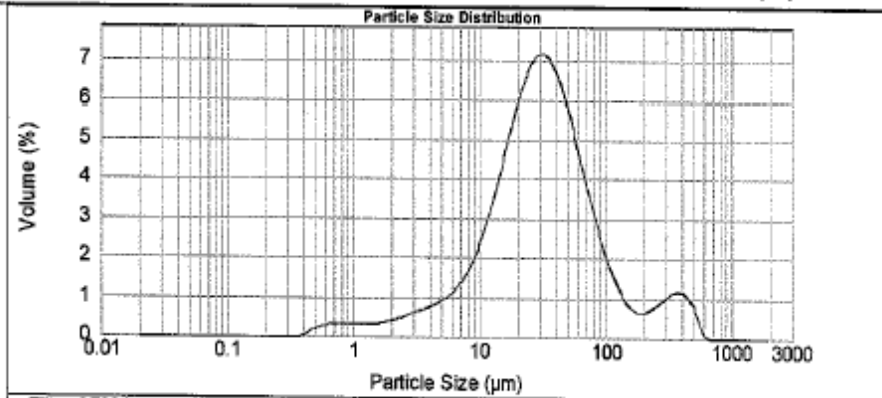

— Filter A72017, 14 October 2005 09:17:29 AM — Filter A72017, 14 October 2005 09:18:05 AM

Size (µm)	Vol Under %	Size (µm)	Vol Under %	Size (µm)	Vol Under %	Size (µm)	Vol Under %	Size (µm)	Vol Under %	Size (µm)	Vol Under %
0.020	0.00	0.142	0.00	1.002	1.48	7.096	9.19	60.238	71.43	355.656	97.08
0.022	0.00	0.159	0.00	1.125	1.72	7.952	10.29	68.368	76.54	390.052	97.95
0.025	0.00	0.178	0.00	1.262	1.94	8.934	11.60	73.246	79.17	447.744	98.78
0.028	0.00	0.200	0.00	1.416	2.17	10.024	13.17	79.993	82.29	502.377	99.47
0.032	0.00	0.224	0.00	1.589	2.40	11.247	15.06	79.521	84.93	563.677	99.92
0.036	0.00	0.252	0.00	1.783	2.66	12.619	17.37	89.337	87.11	632.496	100.00
0.040	0.00	0.283	0.00	2.000	2.95	14.159	20.10	100.237	88.89	709.627	100.00
0.045	0.00	0.317	0.00	2.244	3.27	15.887	23.31	112.468	90.30	795.214	100.00
0.050	0.00	0.356	0.00	2.516	3.63	17.825	27.01	126.191	91.39	893.367	100.00
0.056	0.00	0.399	0.00	2.825	4.03	20.000	31.19	141.589	92.23	1002.374	100.00
0.063	0.00	0.448	0.05	3.170	4.48	22.440	35.81	158.890	92.87	1124.683	100.00
0.071	0.00	0.502	0.17	3.657	4.97	25.179	40.79	178.290	93.39	1261.915	100.00
0.080	0.00	0.564	0.34	3.991	5.50	28.251	46.03	200.000	93.86	1415.962	100.00
0.089	0.00	0.632	0.54	4.477	6.09	31.698	51.39	224.404	94.33	1588.656	100.00
0.100	0.00	0.710	0.77	5.024	6.73	35.588	56.74	251.785	94.87	1782.502	100.00
0.112	0.00	0.796	1.01	5.637	7.45	39.905	61.96	282.508	95.51	2000.000	100.00
0.125	0.00	0.893	1.26	6.325	8.26	44.774	68.88	316.979	96.25		

Operator notes: Pumped @ 2000rpm
Us externally

Figure 10: Particle size analysis of the south bucket at the GCD sampling location.



Result Analysis Report

Sample Name: Filter A72019
SOP Name: [Blank]
Measured: 14 October 2005 09:46:59 AM
Analysed: 14 October 2005 09:47:00 AM
Sample Source & type: Supplier = Inspectorate M&L
Measured by: Theo
Sample bulk lot ref: SDS480

Particle Name: Default
Accessory Name: Hydro 2000MU (A)
Size range: 0.020 to 2000.000 um
Obscuration: 26.96 %
Particle RI: 1.520
Absorption: 0.1
Weighted Residual: 0.783 %
Result Emulation: Off
Dispersant: Water
Dispersant RI: 1.330

Span 2.736 Surface Weighted Mean 12.807 um Vol. Weighted Mean D[4,3]: 56.051 um Result units: Volume
d(0.1): 7.803 um d(0.5): 34.933 um d(0.9): 103.383 um

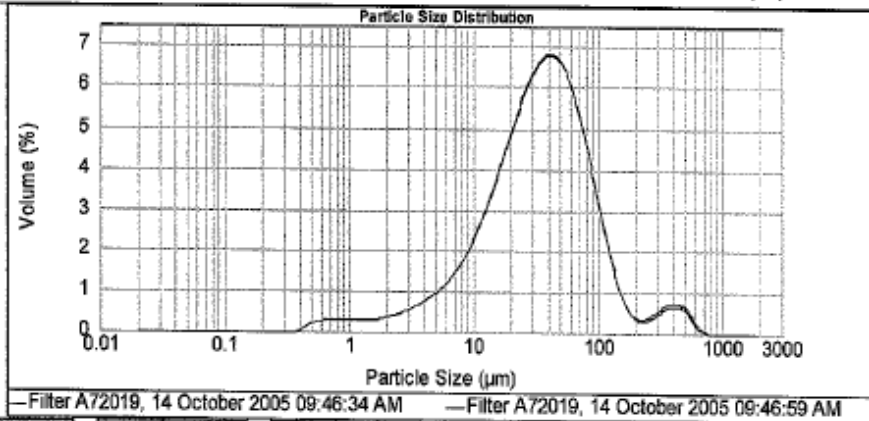

Filter A72019, 14 October 2005 09:46:34 AM		Filter A72019, 14 October 2005 09:46:59 AM	
Size (um)	Vol Under %	Size (um)	Vol Under %
0.020	0.00	0.142	0.00
0.022	0.00	0.159	0.00
0.025	0.00	0.178	0.00
0.028	0.00	0.200	0.00
0.032	0.00	0.224	0.00
0.036	0.00	0.252	0.00
0.040	0.00	0.283	0.00
0.045	0.00	0.317	0.00
0.050	0.00	0.355	0.00
0.055	0.00	0.399	0.00
0.063	0.00	0.448	0.05
0.071	0.00	0.502	0.17
0.080	0.00	0.564	0.34
0.089	0.00	0.632	0.54
0.100	0.00	0.710	0.76
0.112	0.00	0.798	0.99
0.125	0.00	0.898	1.22
1.002	1.44	1.002	1.44
1.125	1.65	1.125	1.65
1.262	1.87	1.262	1.87
1.416	2.07	1.416	2.07
1.589	2.26	1.589	2.26
1.783	2.51	1.783	2.51
2.000	2.75	2.000	2.75
2.244	3.04	2.244	3.04
2.518	3.36	2.518	3.36
2.825	3.72	2.825	3.72
3.170	4.13	3.170	4.13
3.557	4.59	3.557	4.59
3.991	5.12	3.991	5.12
4.477	5.71	4.477	5.71
5.024	6.39	5.024	6.39
5.637	7.16	5.637	7.16
6.325	8.04	6.325	8.04
7.095	9.05	7.095	9.05
7.962	10.22	7.962	10.22
8.934	11.57	8.934	11.57
10.024	13.14	10.024	13.14
11.247	14.97	11.247	14.97
12.610	17.07	12.610	17.07
14.159	19.49	14.159	19.49
15.887	22.23	15.887	22.23
17.825	25.32	17.825	25.32
20.000	28.78	20.000	28.78
22.440	32.58	22.440	32.58
25.170	36.72	25.170	36.72
28.251	41.17	28.251	41.17
31.693	45.87	31.693	45.87
35.598	50.77	35.598	50.77
39.995	55.80	39.995	55.80
44.774	60.87	44.774	60.87
50.238	66.69	50.238	66.69
56.368	70.74	56.368	70.74
63.240	75.34	63.240	75.34
70.963	79.57	70.963	79.57
79.621	83.36	79.621	83.36
89.337	86.64	89.337	86.64
100.237	89.36	100.237	89.36
112.468	91.54	112.468	91.54
126.191	93.18	126.191	93.18
141.593	94.35	141.593	94.35
158.866	95.14	158.866	95.14
178.250	95.65	178.250	95.65
200.000	95.98	200.000	95.98
224.404	96.23	224.404	96.23
251.785	96.49	251.785	96.49
282.508	96.79	282.508	96.79
316.979	97.13	316.979	97.13
356.659	97.55	356.659	97.55
401.052	98.19	401.052	98.19
447.744	98.74	447.744	98.74
502.377	99.25	502.377	99.25
563.677	99.59	563.677	99.59
632.456	99.91	632.456	99.91
709.627	100.00	709.627	100.00
796.214	100.00	796.214	100.00
893.367	100.00	893.367	100.00
1002.374	100.00	1002.374	100.00
1124.683	100.00	1124.683	100.00
1261.915	100.00	1261.915	100.00
1415.892	100.00	1415.892	100.00
1588.656	100.00	1588.656	100.00
1782.502	100.00	1782.502	100.00
2000.000	100.00	2000.000	100.00

Operator notes: Pumped @ 2000rpm
Us externally

Figure 11: Particle size analysis of the east bucket at the RWD sampling location.



Result Analysis Report

Sample Name: Filter A72018 **SOP Name:** **Measured:** 14 October 2005 09:33:37 AM
Sample Source & type: Supplier = Inspectorate M&L **Measured by:** Theo **Analysed:** 14 October 2005 09:33:38 AM
Sample bulk lot ref: SDS476

Particle Name: Default **Accessory Name:** Hydro 2000MU (A) **Size range:** 0.020 to 2000.000 um **Obscuration:** 27.01 %
Particle Rt: 1.520 **Absorption:** 0.1 **Weighted Residual:** 0.731 % **Result Emulation:** Off
Dispersant: Water **Dispersant Rt:** 1.330

Span 4.368 **Surface Weighted Mean** 24.350 um **Vol. Weighted Mean D[4,3]:** 173.413 um **Result units:** Volume

d(0.1): 14.126 um **d(0.5):** 101.721 um **d(0.9):** 458.397 um

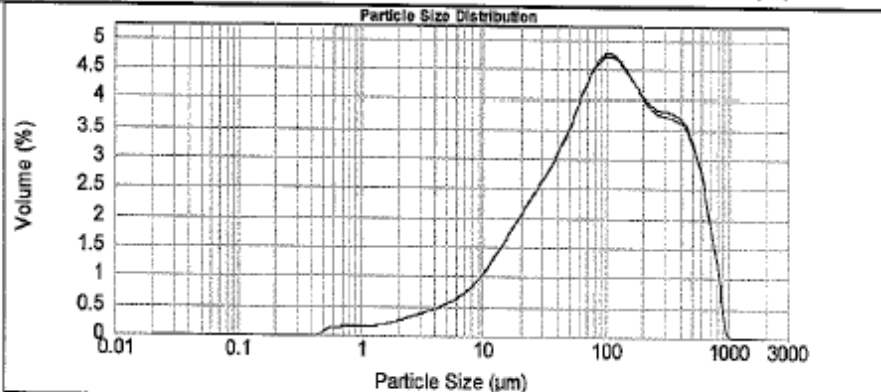

— Filter A72018, 14 October 2005 09:32:47 AM — Filter A72018, 14 October 2005 09:33:37 AM

Size (um)	Vol Under %	Size (um)	Vol Under %	Size (um)	Vol Under %	Size (um)	Vol Under %	Size (um)	Vol Under %	Size (um)	Vol Under %
0.920	0.00	0.142	0.00	1.002	0.61	7.098	5.12	50.238	30.99	355.856	84.03
0.922	0.00	0.159	0.00	1.125	0.72	7.982	5.71	56.368	33.14	398.052	86.78
0.925	0.00	0.175	0.00	1.262	0.84	8.934	6.37	63.246	36.08	447.744	89.47
0.928	0.00	0.200	0.00	1.416	0.98	10.024	7.12	70.983	39.22	502.377	92.02
0.932	0.00	0.224	0.00	1.589	1.09	11.247	7.97	79.921	42.54	563.677	94.36
0.936	0.00	0.252	0.00	1.783	1.24	12.619	8.94	89.337	45.99	632.455	96.39
0.940	0.00	0.283	0.00	2.000	1.42	14.159	10.02	100.237	49.54	709.627	98.03
0.945	0.00	0.317	0.00	2.244	1.61	15.887	11.23	112.408	53.13	795.214	99.19
0.950	0.00	0.355	0.00	2.518	1.83	17.825	12.57	128.191	56.69	893.367	99.90
0.955	0.00	0.399	0.00	2.825	2.08	20.000	14.04	141.589	60.14	1002.374	100.00
0.960	0.00	0.448	0.00	3.170	2.35	22.440	15.63	155.868	63.49	1124.663	100.00
0.965	0.00	0.502	0.02	3.557	2.65	25.179	17.35	178.250	66.70	1261.915	100.00
0.970	0.00	0.564	0.09	3.991	2.98	28.251	19.18	200.000	69.78	1415.882	100.00
0.980	0.00	0.632	0.18	4.477	3.33	31.698	21.14	224.404	72.75	1588.656	100.00
0.100	0.00	0.716	0.28	5.024	3.71	35.568	23.23	251.785	75.83	1782.902	100.00
0.112	0.00	0.796	0.39	5.637	4.14	39.905	25.45	282.508	78.45	2000.000	100.00
0.125	0.00	0.883	0.50	6.325	4.60	44.774	27.84	316.979	81.25		

Operator notes: Pumped @ 2000rpm
 Us externally

Figure 12: Particle size analysis of the west bucket at the KF sampling location.

3.3 Trend Analysis of Precipitant Dust Data

To provide a visual indication of the precipitant dust levels in the different warm-dry periods the bar graphs below indicate the total precipitant dust concentration from each of the export buckets. Please note the change of units on the y-axis of these figures, **grams/m²/warm-dry period**. All previous figures and tables have used milligrams as the mass unit.

The total is calculated by averaging all of the two-week data from October to March for each warm-dry period and then multiplying by the number of days in the warm dry period. Most of the warm-dry periods have thirteen two-week cycles of data and this equates to 182 days (13 X 14 days). Where there have been 14 two-week cycles, the total of 196 days has been used to determine the total.

The Chi Square test for trend method has been used to determine if a linear trend is evident from the data. Chi Square tests for linear trend have been done for the proportions above 600 and 1200 mg m⁻² d⁻¹.

3.3.1 Precipitant Dust Concentrations for the Export Buckets at the Smelting Industry over the Warm-dry Periods

Figure 13 and Figure 14 show a visually decreasing trend over the four warm-dry periods.

The precipitant dust levels at the SG sampling location were very low in the 2004/2005 warm-dry period.

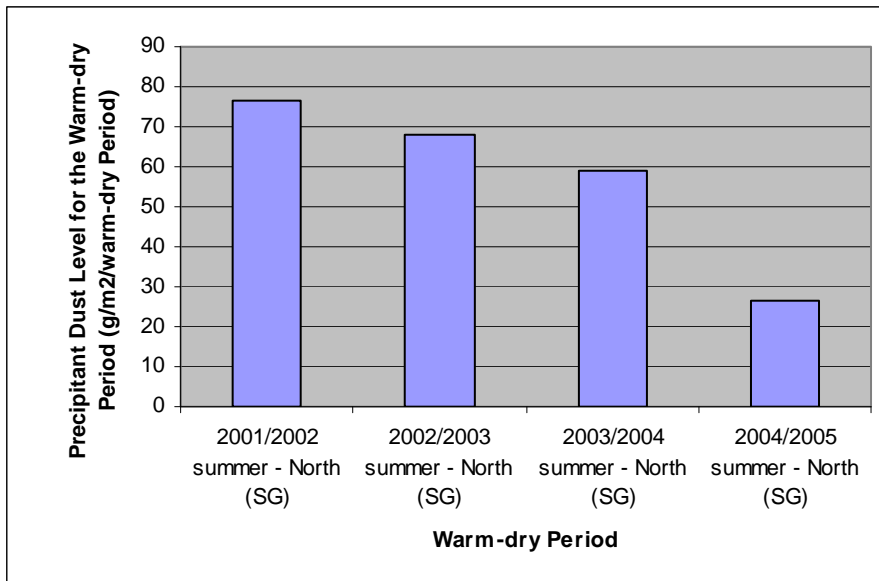

Figure 13: Precipitant dust data for the warm-dry periods for the north bucket of the SG sampling location at the smelting industry.

The precipitant dust concentration decreased consistently over the four warm-dry periods at the SO sampling location.

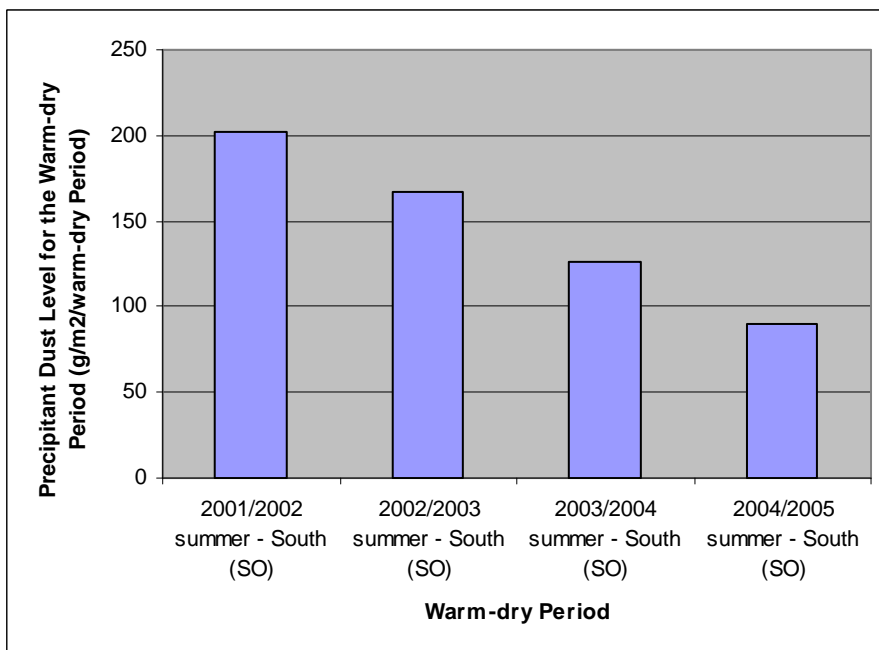

Figure 14: Precipitant dust data for the warm-dry periods for the South bucket of the SO sampling location at the smelting industry.

3.3.2 Precipitant Dust Concentrations for the Export Buckets at the Calcining Industry over the Warm-dry Periods.

From Figure 15 to Figure 22 the visual trends over the four warm-dry periods are indicated for the export buckets at the eight sampling locations of the calcining industry.

Of note is the lack of a visual decreasing trend at many of the sampling locations. Some of the sampling locations indicate a visual increasing trend for some of the warm-dry periods.

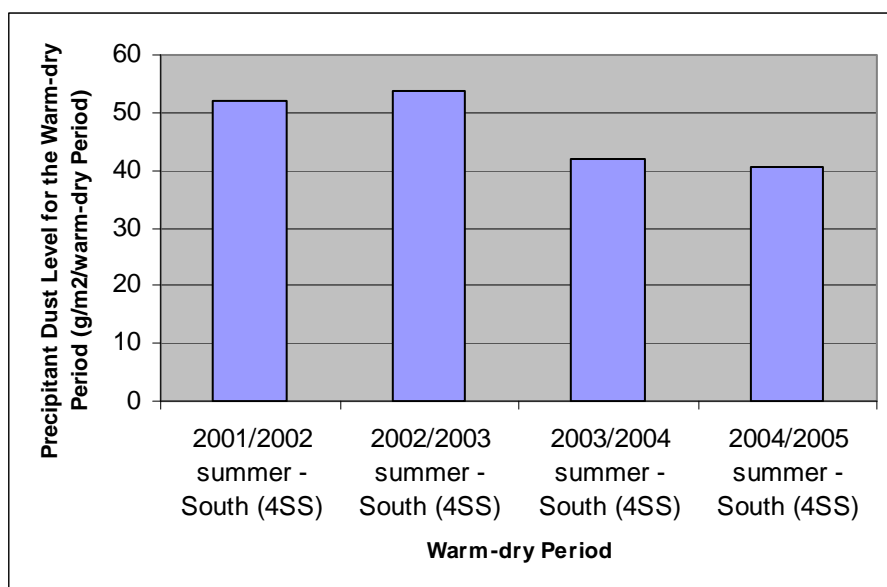

Figure 15: Precipitant dust data for the warm-dry periods for the south bucket of the 4SS sampling location at the calcining industry.

The fourth warm-dry period (2004/2005 warm-dry period) yielded the lowest average precipitant dust concentration over the study period.

Figure 16 indicates an increasing trend in the first three periods and then a decrease for the fourth warm-dry period.

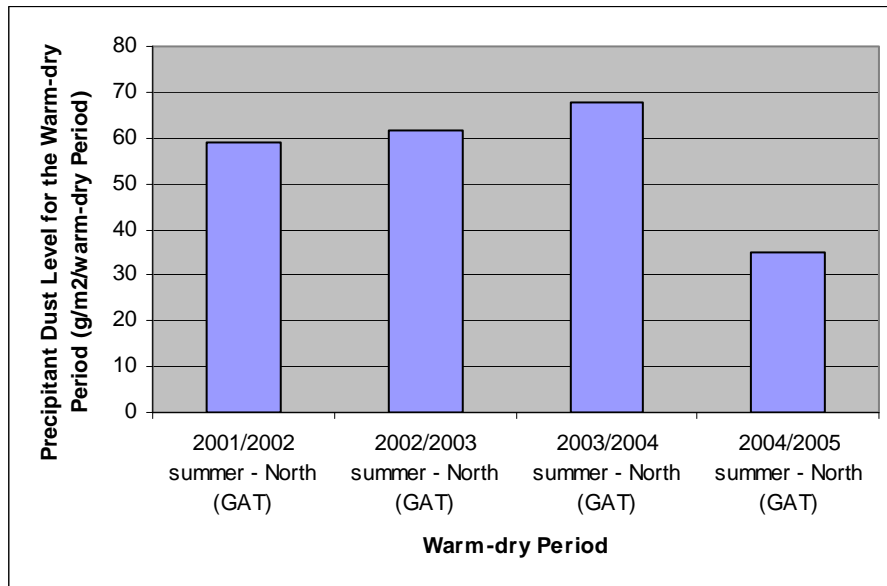

Figure 16: Precipitant dust data for the warm-dry periods for the north bucket of the GAT sampling location at the calcining industry.

No data was collected at the DHF sampling location in the first warm-dry period as shown in Figure 17. Of note here is that the lowest precipitant dust average was in the 2002/2003 warm-dry period.

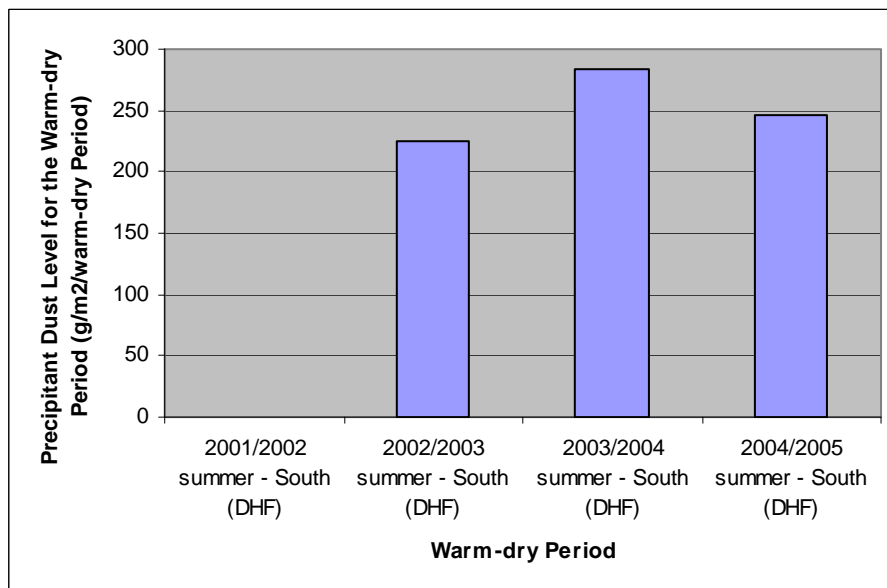

Figure 17: Precipitant dust data for the warm-dry periods for the south bucket of the DHF sampling location at the calcining industry.

There is no data for the second warm period at the KF sampling location as shown in Figure 18. The fourth warm-dry period yielded the lowest average precipitant dust concentration over the study period.

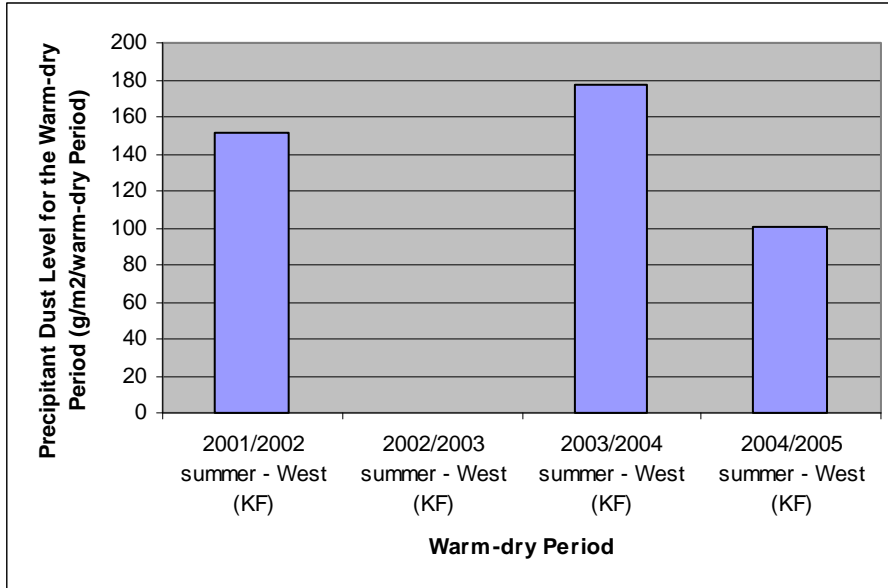

Figure 18: Precipitant dust data for the warm-dry periods for the west bucket of the KF sampling location at the calcining industry.

The fourth warm-dry period yielded the lowest average precipitant dust concentration over the study period, as shown in Figure 19.

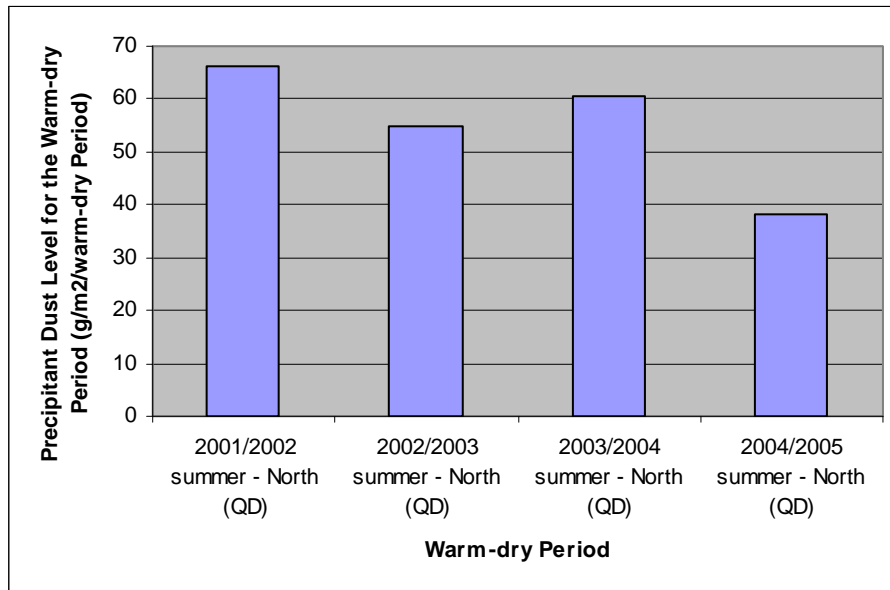

Figure 19: Precipitant dust data for the warm-dry periods for the north bucket of the QD sampling location at the calcining industry.

The second warm-dry period yielded the lowest average precipitant dust concentration over the study period, as shown in Figure 20.

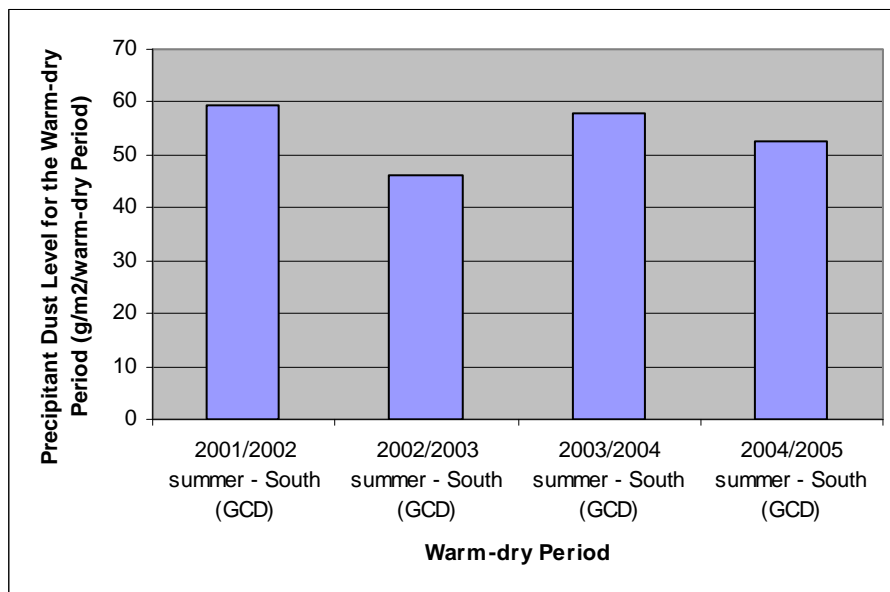

Figure 20: Precipitant dust data for the warm-dry periods for the south bucket of the GCD sampling location at the calcining industry.

The fourth warm-dry period yielded the lowest average precipitant dust concentration over the study period, as shown in Figure 21.

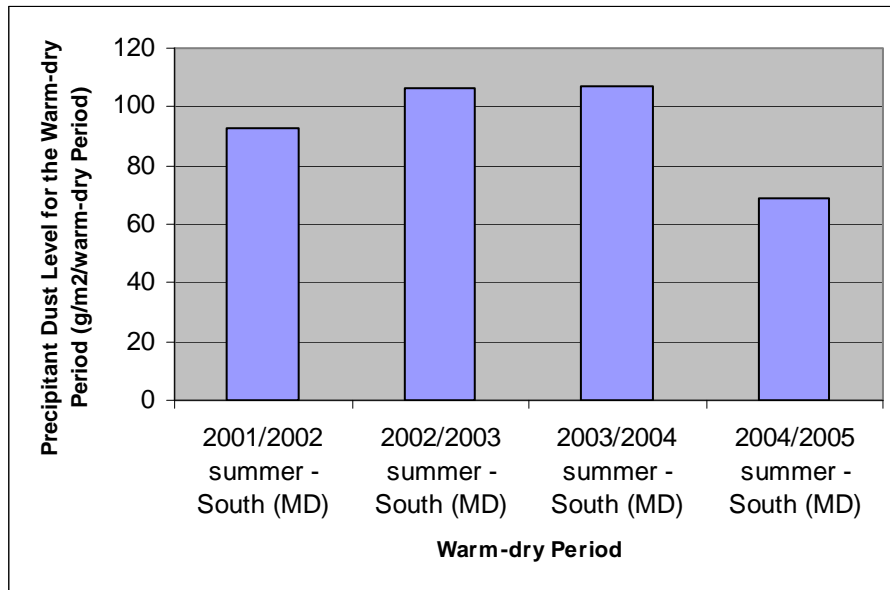

Figure 21: Precipitant dust data for the warm-dry periods for the south bucket of the MD sampling location at the calcining industry.

The fourth warm-dry period yielded the lowest average precipitant dust concentration over the study period, as shown in Figure 22.

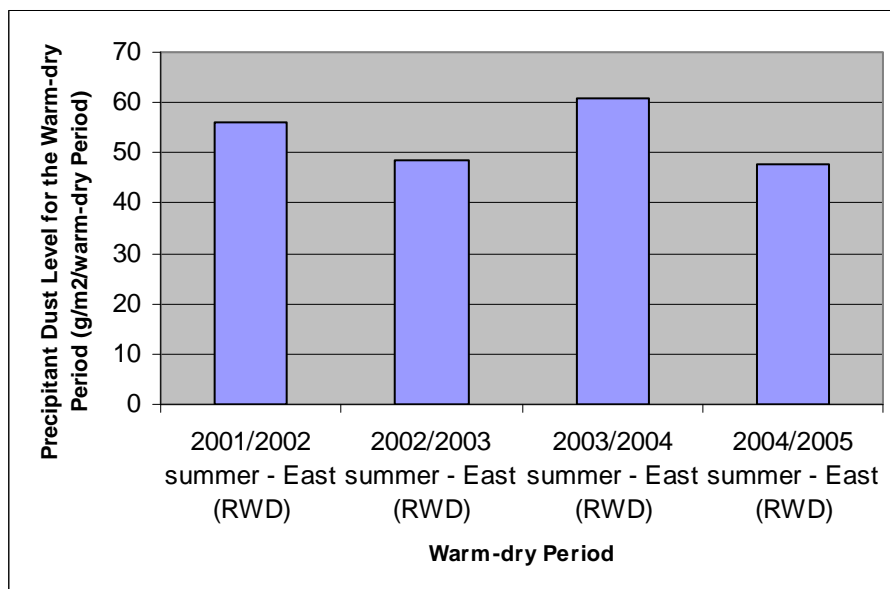

Figure 22: Precipitant dust data for the warm-dry periods for the east bucket of the RWD sampling location at the calcining industry.

3.3.3 Chi Square Test for Trend Results of the Export Buckets for each Sampling Location at the Smelting Industry

The Chi Square test for trend was done on the north bucket of the SG sampling location for proportions above $600 \text{ mg m}^{-2} \text{ d}^{-1}$. A Chi Square value and a p-value of 3.92 and 0.048 were obtained. The p-value was less than 0.05 and a significant reducing linear trend was evident. The Chi Square test for proportions above $1200 \text{ mg m}^{-2} \text{ d}^{-1}$ yielded no results because all of the proportions above $1200 \text{ mg m}^{-2} \text{ d}^{-1}$ were zero.

Similarly the south bucket of the SO sampling location was analysed for proportions above $600 \text{ mg m}^{-2} \text{ d}^{-1}$, yielding a Chi Square value of 13.07 and a p-value of 0.0003. For proportions above $1200 \text{ mg m}^{-2} \text{ d}^{-1}$, the Chi Square value was 7.869 and the p-value was 0.005. The p-value was less than 0.05 for both of the tests done and thus a significant reducing linear trend for the proportions above 600 and $1200 \text{ mg m}^{-2} \text{ d}^{-1}$ was evident.

A significant reducing linear trend was noted at both of the sampling locations at the smelting industry.

3.3.4 Chi Square Test for Trend Results of the Export Buckets for each Sampling Location at the Calcining Industry

In contrast to the sampling locations at the smelting industry, no significant linear trend was noted at any of the sampling locations at the calcining industry.

The Chi Square test for trend was done on the south bucket of the 4SS sampling location for proportions above $600 \text{ mg m}^{-2} \text{ d}^{-1}$. A Chi Square value and a p-value of 1.63 and 0.20 were obtained. The Chi Square test for proportions above $1200 \text{ mg m}^{-2} \text{ d}^{-1}$ yielded no results because all of the proportions above $1200 \text{ mg m}^{-2} \text{ d}^{-1}$ were zero.

The Chi Square test for trend was done on the north bucket of the GAT sampling location for proportions above $600 \text{ mg m}^{-2} \text{ d}^{-1}$. A Chi Square value and a p-value of 1.09 and 0.30 were obtained. The Chi Square test for proportions above $1200 \text{ mg m}^{-2} \text{ d}^{-1}$ yielded

no results because all of the proportions above $1200 \text{ mg m}^{-2} \text{ d}^{-1}$ were zero.

The Chi Square test for trend was done on the south bucket of the DHF sampling location for proportions above $600 \text{ mg m}^{-2} \text{ d}^{-1}$. A Chi Square value and a p-value of 1.50 and 0.22 were obtained. The Chi Square test for proportions above $1200 \text{ mg m}^{-2} \text{ d}^{-1}$ yielded a Chi Square value of 1.52 and a p-value of 0.22.

The Chi Square test for trend was done on the West bucket of the KF sampling location for proportions above $600 \text{ mg m}^{-2} \text{ d}^{-1}$. A Chi Square value and a p-value of 0.18 and 0.68 were obtained. The Chi Square test for proportions above $1200 \text{ mg m}^{-2} \text{ d}^{-1}$ yielded a Chi Square value of 1.47 and a p-value of 0.23.

The Chi Square test for trend was done on the north bucket of the QD sampling location for proportions above $600 \text{ mg m}^{-2} \text{ d}^{-1}$. A Chi Square value and a p-value of 0.21 and 0.65 were obtained. The Chi Square test for proportions above $1200 \text{ mg m}^{-2} \text{ d}^{-1}$ yielded no results because all of the proportions above $1200 \text{ mg m}^{-2} \text{ d}^{-1}$ were zero.

The Chi Square test for trend was done on the south bucket of the GCD sampling location for proportions above $600 \text{ mg m}^{-2} \text{ d}^{-1}$. A Chi Square value and a p-value of 3.40 and 0.07 were obtained. The Chi Square test for proportions above $1200 \text{ mg m}^{-2} \text{ d}^{-1}$ yielded no results because all of the proportions above $1200 \text{ mg m}^{-2} \text{ d}^{-1}$ were zero.

The Chi Square test for trend was done on the south bucket of the MD sampling location for proportions above $600 \text{ mg m}^{-2} \text{ d}^{-1}$. A Chi Square value and a p-value of 1.39 and 0.24 were obtained. The Chi Square test for proportions above $1200 \text{ mg m}^{-2} \text{ d}^{-1}$ yielded a Chi Square value of 0.00 and a p-value of 0.99.

The Chi Square test for trend was done on the east bucket of the RWD sampling location for proportions above $600 \text{ mg m}^{-2} \text{ d}^{-1}$. A Chi Square value and a p-value of 0.57 and 0.45 were obtained. The Chi Square test for proportions above $1200 \text{ mg m}^{-2} \text{ d}^{-1}$ yielded no results because all of the proportions above $1200 \text{ mg m}^{-2} \text{ d}^{-1}$ were zero.

4 DISCUSSION

This chapter discusses the results indicated in the previous section and discusses the descriptive analysis data for both of the industries studied. This is followed by a discussion of the particle size analysis done on four composite samples from the calcining industry. Then the trend analysis of the precipitant dust data for the warm-dry periods is discussed.

4.1 Summary of the Main Findings

All of the data is skewed to the lower ranges. The individual warm-dry and cold-wet period data set is also skewed to the lower ranges. Only one cold-wet period analysis result yielded a median that was higher than the mean and this was at the SG sampling location. The individual warm-dry data is higher than the cold-wet data.

At the smelting industry the SO sampling location yielded higher results than the SG sampling location with the medians being more than double those obtained from the SG location. The area around the SO sampling location was very dusty in the first two warm periods with the 2003/2004 and 2004/2005 warm-dry periods being a lot less dusty. The SO sampling location results exceeded the industrial action level of $1200 \text{ mg m}^{-2} \text{ d}^{-1}$ in the study period while the SG sampling location did not yield any results above the industrial action level of $1200 \text{ mg m}^{-2} \text{ d}^{-1}$ over the study period.

Some of the results at the SO sampling location exceeded the industrial action level of $1200 \text{ mg/m}^2/\text{day}$, even in the cold-wet period. This indicates that rain and climate are not the main influences with regard to the dust generation and that mechanical generation of the dust is occurring as a result of process activities on site. Dust control measures related to the process activities will reduce the precipitant dust levels.

At the calcining industry, the areas near the 4SS and KF sampling locations were dusty at some stage during the study period with results above the applicable action level, $600 \text{ mg m}^{-2} \text{ d}^{-1}$ for the

4SS and $1200 \text{ mg m}^{-2} \text{ d}^{-1}$ for the KF sampling locations respectively. Both of the export buckets at these locations did not exceed their respective action level in the latest warm-dry period (2004/2005). The export bucket at the DHF sampling location exceeded the industrial action level of $1200 \text{ mg m}^{-2} \text{ d}^{-1}$ in all of the warm-dry periods and this area is dusty. Only the RWD (action level $600 \text{ mg m}^{-2} \text{ d}^{-1}$) and DHF (action level $1200 \text{ mg m}^{-2} \text{ d}^{-1}$) sampling location results exceeded the action level in the 2004/2005 warm-dry period.

4.2 Limitations of this Study

Limitations of this study are that only two industrial sites in the Western Cape of South Africa are reported on. Ideally at least one more site should have been added to the study to provide a triangulated view of the precipitant dust concentrations in the Western Cape. With regard to the statistical analysis, the number of data points for the individual warm-dry periods is only thirteen and ideally this should be more to provide a better indication of the individual warm-dry period analysis.

A further limitation is that only one of the four buckets at each sampling location was analysed and that no comparative analysis was done between the different directions. In addition, no comparative analysis was done in relation to the up and down wind results in line with the prevailing wind direction.

The actual time of day that the buckets were changed at the sampling areas was not noted. This is a limitation and the results would be more accurate if this time was recorded.

4.3 Industry and Community View Points on Precipitant Dust

The dust generating activities that generate high precipitant dust levels are usually not continuously generating dust like a stack, and this is what makes it a little more difficult to apply dust control measures. Fortunately it is the non-continuous nature of the dust generating activities that often make the dust control measures fairly simple and cost effective to implement.

The export bucket is regarded as the bucket that collects dust emanating from a particular dust source, although other topographical and climatic conditions can cause the dust from the source to be collected from other directions^{6,17,15}. When industries and communities in South Africa get involved in legal arguments regarding precipitant dust, then the residential and action levels are applied.

The precipitant dust-monitoring programme creates and maintains awareness with regard to dust generating activities. The monthly reports generated on a continuous basis provide information for both parties involved in the dispute to “get their teeth into” and this often eliminates the irrational arguments presented from both parties. Without the precipitant dust information the community usually relies on emotive language to describe the dust that is landing in their community and small dust generating events can be blown out of proportion. From the industry point of view, the information generated from the precipitant dust-monitoring programme can be used as a defence against illegitimate claims from a community, but more importantly it can be used to indicate the dust generating activities on site and provide an indication of continuous improvement from a dust generation point of view.

The actual situation with regard to precipitant dust is usually somewhere between the extreme community complaints and the “there is no problem” attitude from the industry point of view.

The awareness that a simple passive precipitant dust monitoring programme generates is very valuable in another way because the solutions to dust problems are often very simple and sometimes do not require many resources. Some examples of simple dust control measures are positioning dump material in an area shielded from the wind, or delaying the transportation of dusty materials on site when the wind speed is excessively high. These and other cost effective solutions can decrease the precipitant dust levels being exported from an industry.

Both of the industries applied dust control measures over the study period.

Communities often refer to the dust that is visible, even if the dust was only visible for a few minutes. While the amount of dust generated may not contribute significantly to the precipitant dust levels collected from the monitoring programme, limiting these events will go a long way towards easing the tension between the two opposing parties.

4.4 Descriptive Analysis of the Precipitant Dust Data

The descriptive analysis on the whole data set indicates that the data is skewed towards the lower ranges. This supports the notion that high precipitant dust results are often related to dust generating activities, or excessively dry climatic conditions, or a combination of both.¹⁵ Periods of high precipitant dust levels are not the norm and are usually directly related to a dust generating activity on site.

4.4.1 Smelting Industry

The export bucket at the SG sampling location is the north bucket. The SG sampling location collected more dust from the south (see Table 3), with this direction yielding the highest interquartile range and highest mean compared to the north, east, and west directions. The other industrial dust sources to the south of this sampling location, together with the predominant wind direction from the south contributed to the dust collected in the south bucket.

The export bucket at the SO sampling location is the south bucket. The SO unit is positioned within 100m of a coal stockpile and is surrounded by gravel roads. This close proximity to the dust source puts the sampling location within the one kilometre radius, in which most of the dust from the dust source will precipitate to ground level⁵. From Table 3, all four directions at this sampling location collected similar quantities of precipitant dust with the interquartile ranges differing with an amount of up to $40 \text{ mg m}^{-2} \text{ d}^{-1}$.

It is interesting to note that the highest levels of precipitant dust concentrations are not usually in the export buckets and this seems

to indicate that local climatic and topographic conditions play a role in determining where (from which direction) the dust from the smelting industry is collected. Similar findings have been found in the literature.^{6,17,15} Analysis of this relationship is beyond the scope of this research report.

4.4.2 Calcining Industry

The information presented in Table 4 is discussed in this section.

The export bucket at the 4SS sampling location is the south bucket. The south bucket at the 4SS sampling location has the largest interquartile range with the west bucket being just slightly less than the south bucket.

The export bucket at the GAT sampling location is the north bucket. The GAT sampling location collected the most dust from the west with this direction yielding the highest mean and interquartile range compared to the north, south, and east directions.

The export bucket at the DHF sampling location is the south bucket. The highest interquartile range and mean was from the east bucket.

The export bucket at the KF sampling location is the west bucket. The south and west directions collected more precipitant dust than the north and east directions.

The export bucket at the QD sampling location is the north bucket. The west bucket at the QD sampling location collected the most precipitant dust compared to the north, south, and east directions.

The export bucket at the GCD sampling location is the south bucket. This unit was initially only a two-bucket unit monitoring north and south directions. In June 2003 the unit was upgraded to monitor all four directions. The interquartile range for the south bucket was the highest compared to the north, east and west directions.

The export bucket at the MD sampling location is the south bucket. The mean and interquartile range was higher for the west bucket compared to the north, south and east directions.

The export bucket at the RWD sampling location is the east bucket. The south, east, and west directions yielded similar quantities of precipitant dust over the sampling period.

Again the distribution of the precipitant dust concentrations in the different buckets indicates that climatic and topographic conditions play a role in determining which bucket collects the dust. Similar findings have been found in the literature.^{6,17,15} The study of this relationship is beyond the scope of this research report.

4.4.3 South African Legislation Implications

In South Africa the legislation has a $600 \text{ mg m}^{-2} \text{ d}^{-1}$ residential action level and a $1200 \text{ mg m}^{-2} \text{ d}^{-1}$ industrial action level. The action level applicable to a sampling location is dependent predominantly on its proximity to a residential or other similarly dust-sensitive areas as shown in Table 1.⁵

The action levels may be exceeded three times within a year, but they may not be exceeded for more than two consecutive months. When the action levels are exceeded, either by having more than three months in a year above the action level or by having two consecutive months above the action level, the relevant authorities have to be notified.

The action level applicable to the smelting industry sampling locations is the industrial action level, $1200 \text{ mg m}^{-2} \text{ d}^{-1}$. Using the proportions table for the smelting industry the SG sampling location results did not exceed the action level between October 2001 and March 2005. The SO sampling location results exceeded the action level five times in the first warm-dry period (2001/2002 warm-dry period). In the second and third warm-dry periods, the action level was exceeded four times and one time respectively with the action level not being exceeded at all in the 2004/2005 warm-dry period (fourth warm-dry period).

The precipitant dust concentration decreased seemingly on a two year cycle at the SO and SG sampling locations, indicating that dust control measures were not immediately effective. Only when the dust control measures become a part of the procedures and systems on site will they start to consistently control the precipitant dust being exported from site.

Of the eight precipitant dust-sampling locations at the smelting industry, the 4SS, GCD and the RWD locations are subject to the residential action level ($600 \text{ mg m}^{-2} \text{ d}^{-1}$) with the other locations being subject to the industrial action level of $1200 \text{ mg m}^{-2} \text{ d}^{-1}$.

The results at the 4SS sampling location did not exceed the residential action level of $600 \text{ mg m}^{-2} \text{ d}^{-1}$ in the third and fourth warm-dry periods. The limit in the first warm-dry period was exceeded on one occasion. The limit was again exceeded one more time in the second warm-dry period.

The GAT sampling location results did not exceed the industrial action level of $1200 \text{ mg m}^{-2} \text{ d}^{-1}$ from October 2001 to March 2005.

The DHF unit was only installed in April 2002 and was only operational for three of the four warm-dry periods. The industrial action level ($1200 \text{ mg m}^{-2} \text{ d}^{-1}$) has been exceeded at this sampling location six times in the 2002/2003 warm-dry period, eleven times in the 2003/2004 warm-dry period, and nine times in the 2004/2005 warm-dry period.

The KF sampling location results exceeded the industrial action level ($1200 \text{ mg m}^{-2} \text{ d}^{-1}$) in the first warm-dry period three times. No results were obtained from this sampling location in the second warm-dry period. The industrial action level was exceeded six times in the third warm dry period, with the industrial action level ($1200 \text{ mg m}^{-2} \text{ d}^{-1}$) not being exceeded at all in the fourth warm-dry period.

The results at the QD sampling location did not exceed the industrial action level ($1200 \text{ mg m}^{-2} \text{ d}^{-1}$) from October 2001 to March 2005.

The GCD sampling location results exceeded the residential action level ($600 \text{ mg m}^{-2} \text{ d}^{-1}$) twice in the first warm-dry period and once

in the second warm-dry period. The residential action level was not exceeded in the third or fourth warm-dry periods at this sampling location.

The MD sampling location results did not exceed the industrial action level ($1200 \text{ mg m}^{-2} \text{ d}^{-1}$) in the first and fourth warm-dry periods. The results did exceed the industrial action level once in the second and once in the third warm-dry period.

The results at the RWD sampling location exceeded $600 \text{ mg m}^{-2} \text{ d}^{-1}$ twice in the first and twice in the second warm-dry period. The residential action level ($600 \text{ mg m}^{-2} \text{ d}^{-1}$) was then exceeded once in the third and once in the fourth warm-dry period.

It is important to remember that the data collected is two-week data and that the residential and industrial action levels, 600 and $1200 \text{ mg m}^{-2} \text{ d}^{-1}$ respectively, apply to monthly average results. The interpretation of the legislation can be quite tricky; especially if cycles of data are missing and after more court cases have dealt with the legislation then precedents will be set to assist in the interpretation.

Two-week data provides an easier routine with regard to bucket changes, limits the loss of data to a two-week period instead of a month, and provides an earlier indication that the precipitant dust concentrations are increasing, so that action can be taken to prevent monthly average results from exceeding the action level. While results are normally presented to the industries on a monthly basis, two-week results can be presented to the industries by exception if they are busy implementing dust control measures or if the precipitant dust levels are close to the applicable action level. The two-week bucket changing also helps to prevent the build-up of algae in the buckets, and birds from contaminating a whole month's data. The buckets are also not likely to dry out in a two-week cycle, thus ensuring that the bucket always has water available to retain the dust once it has fallen into the bucket. The use of water as a capture the dust is also found in the literature.²³

4.5 Particle Size Analysis of the Precipitant Dust Samples

Four of the export buckets around the calcining industry were selected for particle size analysis:

- The north bucket of the GAT sampling location
- The south bucket of the GCD sampling location
- The east bucket of the RWD sampling location
- The west bucket of the KF sampling location

The particle size analysis performed on the precipitant dust indicates that the dust is predominantly less than 100 μm , with the exception being the analysis done on the east bucket of the KF sampling location. The particulate size of less than 100 μm is similar to the size of precipitant dust particulate from fugitive dust sources.⁴

The analysis performed on the KF sampling location indicates that more than fifty percent of the dust collected was above 100 μm . The KF unit is positioned in the middle of a wheat farmland and the area is ploughed and worked on at various times of the year.

Agricultural land is known to be a source of dust⁴ and the large fraction of particles above 100 μm indicates that dust from within 100 meters of the sampling location was either gusted into the buckets by wind or mechanically agitated and lifted into the air during calm conditions. The area is also home to sheep and ostriches that could cause the dust in the vicinity of the sampling location to be deposited in the buckets.

The definition of PM_{10} particulate is based on the collection efficiency of a PM_{10} monitor that yields an aerodynamic d_{50} for the dust collected equal to 10 μm . This means that the PM_{10} particulate can vary from 0 to about 17 μm , depending on the size distribution within this size range. For the purpose of this discussion an upper limit of 15 μm has been used.

A very interesting observation from the analysis is that a significant percentage of the particles by volume are under 15 μm . The RWD,

GAT, and GCD sampling locations all indicate that about 22 percent of the particles by volume are less than 15 μm in size. The KF location analysis indicates that only about eleven percent of the dust is less than 15 μm and the lower percentage is probably due to the contamination of the sample by the particulate larger than 100 μm .

Many countries including the United States of America (USA) do not consider precipitant dust as an indication of atmospheric environmental and health conditions¹⁶. These countries use more expensive active atmospheric monitoring equipment to determine the PM_{10} and $\text{PM}_{2.5}$ dust concentrations in the atmosphere.¹⁶ The fact that the PM_{10} fraction of dust is collected in the precipitant dust monitoring units means that precipitant dust methods could be used to correlate to the PM_{10} dust concentrations once the appropriate research has been done in an area. While there is currently no method to convert precipitant dust concentrations to PM_{10} concentrations¹¹, the correlation is most likely going to be specific to the topography and climate of the area and to the sources of PM_{10} particulate matter.

If the sources of PM_{10} are from the same sources as the precipitant dust, then measurements of the precipitant dust concentrations will be able to indicate if the PM_{10} concentrations are being controlled. This excludes sources from high temperature emissions such as combustion and smelting processes.

In South Africa and many other countries, the cost of doing PM_{10} and $\text{PM}_{2.5}$ atmospheric monitoring is very high and often the monitoring systems do not operate efficiently enough to provide data that can be reliably used to determine environmental and health risk trends. With passive monitoring systems it is often possible to have more monitoring stations and this normally provides more reliable data than active monitoring systems.²⁵

Precipitant dust contains pollens, spores, and viruses², and particulate less than 40 μm ^{9,10} can enter the nasal passages, which is a health risk^{5,8} for allergies, sensitisations and asthma.^{9,10} The percentage of particles by volume below 40 μm was found to be

above 60 percent for the three log-normally distributed particle size analysis done.

With the passive nature of precipitant dust monitoring and the reliability of the monitoring programmes as shown by the four years of data collected at the ten sampling locations discussed in this report, the cost of PM₁₀ and PM_{2.5} monitoring programmes could be achievable for third world countries.

4.6 Smelting Industry - Precipitant Dust Data Trends

This is a winter rainfall area.

4.6.1 SG Precipitant Dust Sampling Location

The export bucket yielded visually significantly lower results in the 2004/2005 warm-dry period. The reason for this significant decrease in the precipitant dust concentration is attributed to the concreting of a gravel road passing near to the sampling location and to the awareness of dust sources on site by the smelting industry. Gravel roads are a common source of fugitive dust⁴ and the tarring of a road can therefore significantly improve the precipitant dust conditions.

The p-value obtained from the Chi Square test for linear trend indicates that there is a significant reducing linear trend in the data from October 2001 to March 2005. This reducing trend is an excellent indication of continuous improvement with regard to precipitant dust concentrations.

4.6.2 SO Precipitant Dust Sampling Location

The export bucket precipitant dust concentrations indicate a visually reducing trend from October 2001 to March 2005. The precipitant dust concentration in the fourth warm-dry period is more than fifty percent less than the level of the first warm-dry period precipitant dust concentrations and this is an improvement of more than 100 percent in four years. The data indicate that the warm period precipitant dust concentrations are significantly less every two years, i.e. Improvements in dust control measures take

two years to yield significantly lower precipitant dust concentrations at the SO sampling location. The control measures implemented were to limit activity during windy conditions.

The Chi Square test for linear trend indicates that there is a significant reducing linear trend, and continuous improvement at the smelting industry over the study period is evident.

4.7 Calcining Industry - Precipitant Dust Data Trends

This is in a winter rainfall area.

Six of the eight precipitant dust-sampling locations at the calcining industry yielded the lowest precipitant dust concentration in the 2004/2005 warm-dry period (fourth warm-dry period) and this indicates improvement to some extent at these six sampling locations.

The DHF and GCD sampling locations are the two locations that did not yield the lowest precipitant dust concentration in the fourth warm-dry period.

None of the p-values for the Chi Square test for linear trend are below 0.05 with the lowest p-value being 0.07 from the GCD analysis.

This indicates that there is no significant linear trend at any of the calcining industry precipitant dust sampling locations.

This also indicates that no continuous improvement at the calcining industry has been evident over the study period.

The dust control measures implemented by the calcining industry did not result in a decrease in the precipitant dust levels. The study of the dust control measures implemented and the related improvements in precipitant dust levels is beyond the scope of this report.

5 CONCLUSIONS AND RECOMMENDATIONS FOR FUTURE STUDY

This chapter has the conclusions and recommendations followed by the recommendations for future study.

The warm-dry period precipitant dust concentrations are higher than the cold-wet period precipitant dust concentrations.

The particle size of the precipitant dust is normally from 0 to 100 μm with up to 22 percent (by volume) of the particles being smaller than 15 μm . Localised dust sources can be collected in the precipitant dust monitoring units and care needs to be taken to limit non-industrial dust generating activities within close proximity to the units.

There has been a significant decrease in the precipitant dust concentrations to the north and south of the smelting industry from October 2001 to March 2005. The recommendations for the smelting industry are that they continue to eliminate fugitive dust sources and that they continue to maintain a high awareness of dust control. The coal stockpile should be targeted with regard to dust control measures, such as barriers to limit the wind speed over the stockpile, barriers at the transfer points to limit dust generation, and procedures to limit activity during high wind conditions. The over filling of transportation vehicles will also limit dust emissions. Water sprays can be added to make the surface layer of the stockpile heavier, thus decreasing the dust emissions.

The precipitant dust concentrations around the calcining industry have not declined significantly over the study period. The recommendations for the calcining industry are that they be more proactive with regard to dust control measures, especially near to the DHF sampling location. The DHF sampling area should be targeted for dust control measures, with the most effective method being to use water, as this material is not going to be processed again in the short term. Another possibility would be to find a new dump location that is out of the prevailing wind direction, such that

the prevailing wind will not result in emissions blowing towards farms and residential areas.

5.1 Considerations for Future Studies

A further course of study would be to consider the mitigation methods used by the respective industries, and to determine how effective or ineffective the methods were.

Another further course of study would be to do comparative analysis of the four directions at each sampling location and to do comparisons between results in line with the prevailing wind direction. Additional analyses such as time series, additional particle size distributions, chemical analysis, and analysis of wind direction and speed from the data set presented in this research report would also be of value.

Using time series analysis the precipitant dust levels could be predicted using a formula determined from the retrospective data. Additional particle size distributions, especially from the smelting industry, to see if the particle size distribution followed similar patterns to the calcining industry would be of value. Chemical analysis would be able to provide an indication of the sources of the dust, especially if the emission from an industry is unique and not found in the general environment. The analysis of wind direction and speed, while very complicated, would be able to assist in identifying the most troublesome dust sources and assist in the design and timing of dust control measures.

Future study of the climatic effects on the precipitant dust levels would also be beneficial to assist in predictive modelling of the expected precipitant dust levels under certain climatic conditions (rainfall, wind speed, and wind direction).

Future study should include the ambient particulate concentration calculation using the dry deposition rates, calculated either by using a differential terminal settling velocity calculation or by using the ratio^{15,18} of the precipitant dust concentration to the airborne concentration of the pollutant. The size analysis of the dust in both of the above calculations will most likely be very important.

A further course of study would be to then determine the elemental concentrations of the precipitant dust and the airborne dust to try and determine a relationship that will most likely be site-specific and may also be season-specific. Another consideration for the future study of precipitant dust and how it relates to airborne dust concentrations will also probably have to make a clear distinction between dry and wet deposition.¹⁸

The chemistry of the atmosphere is very complex and with the strict pollution control limits being set there is a potential for pollutants that were not previously a problem, to become a problem because the chemistry in the atmosphere has been altered by the removal of certain particles and gasses.³⁰

Many factors can affect particulate deposition, namely: atmospheric stability; the diameter and surface characteristics of the particles and the macro and micro surface roughness. This makes particulate deposition a complex process.¹⁶

A lot of research has been undertaken on the effects of phytotoxic pollutants (e.g. SO₂, NO₂, & O₃), but very little research has been done on the effect of dust pollution on vegetation. The research that has been done reveals that this could be of significant importance, and it therefore warrants a closer look.¹⁰

An applicable model for particulate deposition has yet to be created because of “inadequate knowledge of the mechanism and factors governing dry deposition of particulate matter to diverse surfaces.”¹⁶ This has also hindered attempts to develop suitable measurement techniques for particle deposition.¹⁶

The effects of increased humidity due to vegetation warrants further study, as the effects of the expansion of hygroscopic particles close to deposition surfaces is yet to be explored.¹⁶ “... a comprehensive understanding of particulate deposition remains a distant goal.”¹⁶

The mechanisms of particle formation, dispersion, transportation and deposition ruling the particulate matter concentration in air are strongly connected to the atmospheric conditions.¹⁹

While wind direction and velocity are normally shown together with precipitant dust data¹⁹, the interpretation of the data is not

straightforward. Future study in this area needs to consider attempting to correlate precipitant dust data with the amount of time when the wind speed is below 3m/s. Additional study of the other buckets, not only the export bucket, would also provide information with regard to the import of dust from surrounding sources.

There are also indications that the “different portions of the dust”¹⁹ may be influenced by seasonal variations¹⁹ and this provides the motivation for the future study of the different size fractions and chemical compositions of the precipitant dust.

The accuracy of models for the precipitant dust levels is not well known especially when the varying land use and atmospheric conditions are taken into account.³¹ This supports the future study objective to develop area specific models by using actual measurements. Once the model is deemed accurate enough and representative of the full annual seasonal variations then low costs precipitant dust monitoring may be able to predict the PM₁₀, PM_{2.5} and other atmospheric pollutant concentrations.

The importance of the “environmental consequences”¹⁶ caused by precipitant dust and other atmospheric pollutants must not be ignored as the loss of environmental ecosystems and plant species may in the long-term result in significant problems from a human perspective.¹⁶

Many environmental problems and other health hazards may be missed when analyzing particulate matter because it is never made up of a singular pollutant, but rather, it is a heterogeneous mixture, made up of different particles.¹⁶ These particles differ in chemical composition, origin and size. The solution is that other definitions of the particulate matter must be explored, instead of only defining particulate matter by its size fraction.¹⁶

6 REFERENCES

- ¹ The Wind and the Watershed: Pollen and Pollution. Envirocast Newsletter. 2003;1(5). Available at: URL: <http://www.stormcenter.com/envirocast/2003-03-01/envirocast-article1.php>. Accessed June 26, 2006.
- ² Chen Y, Barber EM, Zhang Y. Statistical analysis of a steady-state method for estimating dust production and deposition rates in a ventilated airspace. *Bull Environ Contam Toxicol* 1998;60:677-84.
- ³ James Dorsey's Atmospheric Physics Online Resource. 1999:[20 screens]. Available at: URL: <http://cloudbase.phy.umist.ac.uk/people/dorsey/res.htm>. Accessed June 4, 2006
- ⁴ Countess Environmental. WRAP fugitive dust handbook. 2004:[191 pages]. Available at: URL: <http://ndep.nv.gov/baqp/WRAP/final-handbook.pdf>. Accessed May 03, 2005
- ⁵ Controlling the environmental effects of surface mineral workings. Annex B: The control of dust at surface mineral workings. 1998:[25 pages]. Available at: URL: <http://www.scotland.gov.uk/library5/planning/pan50ab.pdf>. Accessed May 03, 2005.
- ⁶ Forecasting Dust Storms. 2002:[58 screens]. Available at: URL: <http://meted.ucar.edu/mesoprim/dust/print.htm>. Accessed July 27, 2005.
- ⁷ Brown R. "Brownian Motion." In: Halsey WD, Shores L, editors. *Collier's encyclopedia with bibliography and index*. Macmillan Education Corporation; 1974. vol 4 p. 620.
- ⁸ Farfel MR, Orlova AO, Lees PSJ, Rohde C, Ashley PJ, Chisolm Jr. JJ. A study of urban housing demolitions as sources of lead in ambient dust: Demolition practices and exterior dust fall. *Environ Health Perspect* 2003 Jul;111(9):1228-34.
- ⁹ Lewis RD, Sterling DA, King B, Hendershott L, Goodgold H, Hutcheson P. Evidence of large particle allergen inhalation from contact with surfaces. *Ann Allergy Asthma Immunol* 1999 Jul;83:41-8.

-
- ¹⁰ Farmer AM. The effects of dust on vegetation – a review. *Environ Pollut* 1993;79:63-75.
- ¹¹ Australian Government – Department of the Environment and Heritage. 1998:[25 screens]. Available at: URL: <http://www.deh.gov.au/settlements/industry/minerals/booklets/dust/dust1.html#1> Accessed July 26, 2005.
- ¹² Standard test method for collection and measurement of dustfall (Settleable particulate matter). Designation: D 1739-98. West Conshohocken, PA: (Reprinted from the Annual Book of ASTM standards)
- ¹³ DustWatch – Fallout dust monitoring – Sampling and assessment procedure manual. 2005. Available from Gerry Kuhn Environmental and Hygiene Engineering: URL: <http://www.gkehe.8m.com>. Accessed May 03, 2005.
- ¹⁴ Rodrigues M. New dust monitoring technology developed. *Engineering News* 2002;11:weekly feature.
- ¹⁵ Satsangi GS, Lawrence AJ, Lakhani A, Taneja A. Assessment of the potential for soil acidification in North India using the critical load approach and locally derived data for acidic and basic inputs. *Chemosphere* 2003;53:1011-21.
- ¹⁶ Grantz DA, Garner JHB, Johnson DW. Ecological effects of particulate matter. *Environ Int* 2003;29:213-39.
- ¹⁷ Australian government – Department of the environment and heritage. 1998:[20 screens]. Available at: URL: <http://www.deh.gov.au/settlements/industry/minerals/booklets/dust/case2.html>. Accessed July 26, 2005.
- ¹⁸ Moon H, Lee S, Choi H, Ok G. Atmospheric deposition of polychlorinated dibenzo-*p*-dioxins (PCDDs) and dibenzofurans (PCDFs) in urban and suburban areas of Korea. *Chemosphere* 2005;58:1525-34.
- ¹⁹ Papaefthymiou H, Kritidi P, Anousis J, Sarafidou J. Comparative assessment of natural radioactivity in fallout samples from Patras and Megalopolis, Greece. *J Environ Radioact* 2005;78:249-65.

-
- ²⁰ South African National Standard. SANS1929:2005 Draft; ISBN 0-626-2005; p.13.
- ²¹ Azimi S, Rocher V, Muller M, Moilleron R, Thevenot DR. Sources, distribution and variability of hydrocarbons and metals in atmospheric deposition in an urban area (Paris, France). *Sci Total Environ* 2005;237:223-39.
- ²² Jiries A, El-Hasan T, Manasrah W. Qualitative evaluation of the mineralogical and chemical composition of dry deposition in the central and southern highlands of Jordan. *Chemosphere* 2002;48:933-8.
- ²³ Brooks K, Schwar MJR. Dust deposition and the soiling of glossy surfaces. *Environ Pollut* 1987;43:129-41.
- ²⁴ Pettersson HBL, Koperski J. Investigation of aerial dispersion of radioactive dust from an open-pit Uranium mine by passive vinyl collectors. *Health Phys* 1991;60:681-90.
- ²⁵ Schneider T, Schlünssen V, Vinzents PS and Kildesø J. Passive sampler used for simultaneous measurement of breathing zone size distribution, inhaleable dust concentration and other size fractions involving large particles. *Ann Occup Hyg* 2002;46(2):187-95.
- ²⁶ Annex 1 - The control and mitigation of dust at mineral and related workings. [25 screens]. Available at: URL: http://pilsley.portland.co.uk/documents/andy/odpm_plan_source_605888Annex%201.doc. Accessed June 2, 2006.
- ²⁷ Kuhn GF, Loans C. Practical determination and location of windblown dust sources and how to establish a good monitoring program. *Chemical Technology* 2003 Nov;11:27-9.
- ²⁸ H2O Water Purifiers. Available at: URL: <http://www.h2o.co.za/>. Accessed September 19, 2007.
- ²⁹ South Africa's Weather and Climate. [2 screens]. Available at: URL: http://www.southafrica.info/plan_trip/travel_tips/questions/climate.htm. Accessed January 7, 2007.
- ³⁰ Larssen T, Carmichael GR. Acid rain and acidification in China: the importance of base cation deposition. *Environ Pollut* 2000;110:89-102.

³¹ Etyemezian V, Ahonen S, Nikolic D, Gillies J, Kuhns H, Gillette D, et al. Deposition and removal of fugitive dust in the arid southwestern United States: Measurement and model results. *J Air Waste Manag Assoc.* 2004 Sep;54:1099-111.

APPENDIX A. Step by Step Description of the Method Used to Obtain the Precipitant Dust Data.

1. Bucket Preparation

- Clean the buckets well, making sure that no dust or particulate remains in the buckets.
- Rinse out with a little distilled water, discarding this rinse water.
- Partially fill with distilled water, allowing for the expected rate of evaporation appropriate to the expected rate of sampling as outlined in Table 10. These are rough figures and conditions in your area will dictate exact water requirements.

Table 10: Amount of water required for different climatic conditions.

WEATHER CONDITIONS	1 WEEK	2 WEEKS	3 WEEKS	4 WEEKS OR 1 MONTH
Hot dry warm periods	2.5 litres	3.5 litres	4.0 litres	4.0 litres + check after 3 weeks
Hot wet warm periods	2.0 litres	2.5 litres	3.0 litres	3.5 litres + check after 3 weeks
Cool dry cold periods			2.5 litres	3.5 litres
Cold dry cold periods		3.0 litres		
Wet cold periods		2.0 litres		3.0 litres + check after 3 weeks

- It is not critical to measure the water accurately and the above approximations are good enough. It should be noted that with any longer period of measurement the water should be topped up to prevent total loss of water, which will result in some loss of dust or alternatively failure to catch dust adequately during the period when the bucket is dry.
- Add an amount of 5 ml to 10 ml of bleach or proprietary product to each bucket as an algaecide, depending on how full the buckets will be kept. Top-up water does not have to be similarly dosed with bleach.
- Seal the buckets with the lids, adding labels to the bucket lids.
- For one week sampling, the hypochlorite may be omitted in cold periods, and pure distilled water used instead. During such a short period algae will not have time to grow.
- Transport buckets to site.

2. Bucket Collection Procedure

- The bucket support cradle must be dropped by unlocking and removing the retaining pin before sliding the support assembly down the pole. Reposition the cradle at the lower level without twisting the buckets to confuse directionality.
- One bucket must be removed at a time and replaced with a pre-prepared bucket, using the labelled lid to seal the removed bucket, taking care to label the sample buckets correctly.
- Lift the support assembly back into position; replace the retaining pin and lock into position.

- Any notes should be made in the field book before proceeding to the next DustWatch unit.
- Check the unit operation by spinning the selector to ensure free movement.

3. Filtering Procedure

- The clean Buchner funnel assemblies should be fitted with the pre-weighed and marked filter papers, making sure that the filter paper is located to prevent by-pass leakage around the filter.
- The contents of one bucket must be loaded into each funnel after +1mm discard solids are strained out (small tea strainer works well) and the vacuum pump started.
- Filter numbers must be entered against the designation of the collected bucket on the assessment form.
- Enter all relevant information on the assessment form.
- On completion of the filtering process, remove the filters, place these in the petri dishes, partially covering the filters, and allow these to desiccate on a low wattage light box or under a 60-watt lamp about 600 mm above.
- The filter + solids must be weighed once the filters have been desiccated. The stage at which full desiccation has been achieved is defined under “Weighing Procedure”.
- The filter mass must be noted on the assessment form.
- 100 ml of the filtrate solution should be retained if the soluble content of the captured sample is also to be assessed and weighed. The total remaining water must be measured and the quantity added to the assessment sheet to determine the amount of dissolved solids.

- The above filtrate solution should be boiled off over a low Bunsen or heat source (hot plate) to accelerate the boiling off. The initial operation can be undertaken in a microwave oven and the beaker transferred to a hot plate for the final desiccation.

The filtrate solids from the beaker must be collected and weighed, entering the mass on the assessment form as soluble solids.

4. Weighing Procedure – Filter Preparation

- Stabilise filters in the laboratory or weighing room for 8 hours or keep stocks in an unsealed partly ventilated container so that they are continuously stable for the laboratory conditions.
- Filter papers are individually marked using a ballpoint pen. Ensure that the ink has dried before proceeding with any weighing operations. Should filtrate be required to establish Alpha short or long-lived particles, no marking of the filters must be undertaken.
- Each filter must be placed in its own petri; the petri dishes should also be temporarily marked with the filter number and if preferred, the DustWatch unit and bucket number.

5. Weighing Procedure – Filter/Filtrate Weighing

- Initial desiccation in a dust free environment for a minimum of 24 hours must be allowed or until all sample moisture evaporation has stopped.
- Desiccated filters are placed on the balance and permitted to remain on the pan for about 60 seconds. If there is any indication of a continuous fall in mass, it means that the

filter/filtrate is not completely desiccated and the sample must be removed for further drying.

- If the mass remains stable, remove the filter, allow the balance to zero and reweigh the filter.

6. Calculations

- The cross-sectional area of the buckets is a standard constant in all of the calculations representing the area over which precipitant dust collection has been made, 0.02545m².
- The actual mass collected is derived by subtraction of the mass of the filter (mass1) from the combined mass of the filter and filtrate (mass2). $Mass_2 - mass_1 = \text{collected mass of dust sample}$.
- All units should be expressed in milligrams and the value of milligram/square metre/day derived from the formula:

$$\text{Precipitation rate (mg m}^{-2} \text{ d}^{-1}) = \frac{\text{collected mass X 1}}{0.02545 \text{ X days}}$$

- Should you require to express the units as per month (g/m²/30 days) and a two-week sampling period is being used, then the following calculation can be used.

$$\frac{\text{Precipitation rate 1}^{\text{st}} \text{ period} + \text{Precipitation rate 2}^{\text{nd}} \text{ period}}{2} \times 30 \text{ days}$$

7. Limitations of Sampling and Filter materials

- The type of filter paper used and the location of the DustWatch unit in relation to the source of the dust dictate the sample capture restraints.
- Generally finer suspended dust ($2.5\mu\text{m} > 5\mu\text{m}$) will remain airborne almost indefinitely due to the dynamic nature of the air currents and thermal activities on any given day, even if there is no wind at all. A rapid increase in humidity together with an absence of wind will result in precipitation of less than 5 micron particulate.
- Particulate larger than about $5\mu\text{m}$ will settle on a very still day and this material is collected within the DustWatch buckets in varying amounts depending on the wind turbulence.
- Particulate of a large size, 500 micrometers, carried by high wind velocities will not be collected within the buckets due to the aerodynamic shape and wind screening effect of the selector disk. This acts much like the wing of an aircraft, which produces a high-pressure area below the disk, keeping the gritty particulate from falling into the buckets. The disk optimum efficiency occurs at wind velocities exceeding 3.0m/s. At velocities below 3.0 m/s no particulate of this size is lifted higher than a maximum of about 2.0m.
- Once the wind drops to lower levels the particulate starts precipitating and this gets captured in the buckets. We thus note that no dust gets captured during very windy conditions but only when the wind speed drops. Once the wind changes, the maximum precipitation rate is reached when the air mass movement is totally arrested and then starts to move in the opposite direction.

From the above we thus selected filter material with a pore size of about $5\mu\text{m}$. The filter papers weave permits capture of $1\text{-}2\mu\text{m}$ particulate and thus the actual collection guarantee is a lot better than $5\mu\text{m}$.



Figure 23: Cradle of the DustWatch unit that holds the buckets

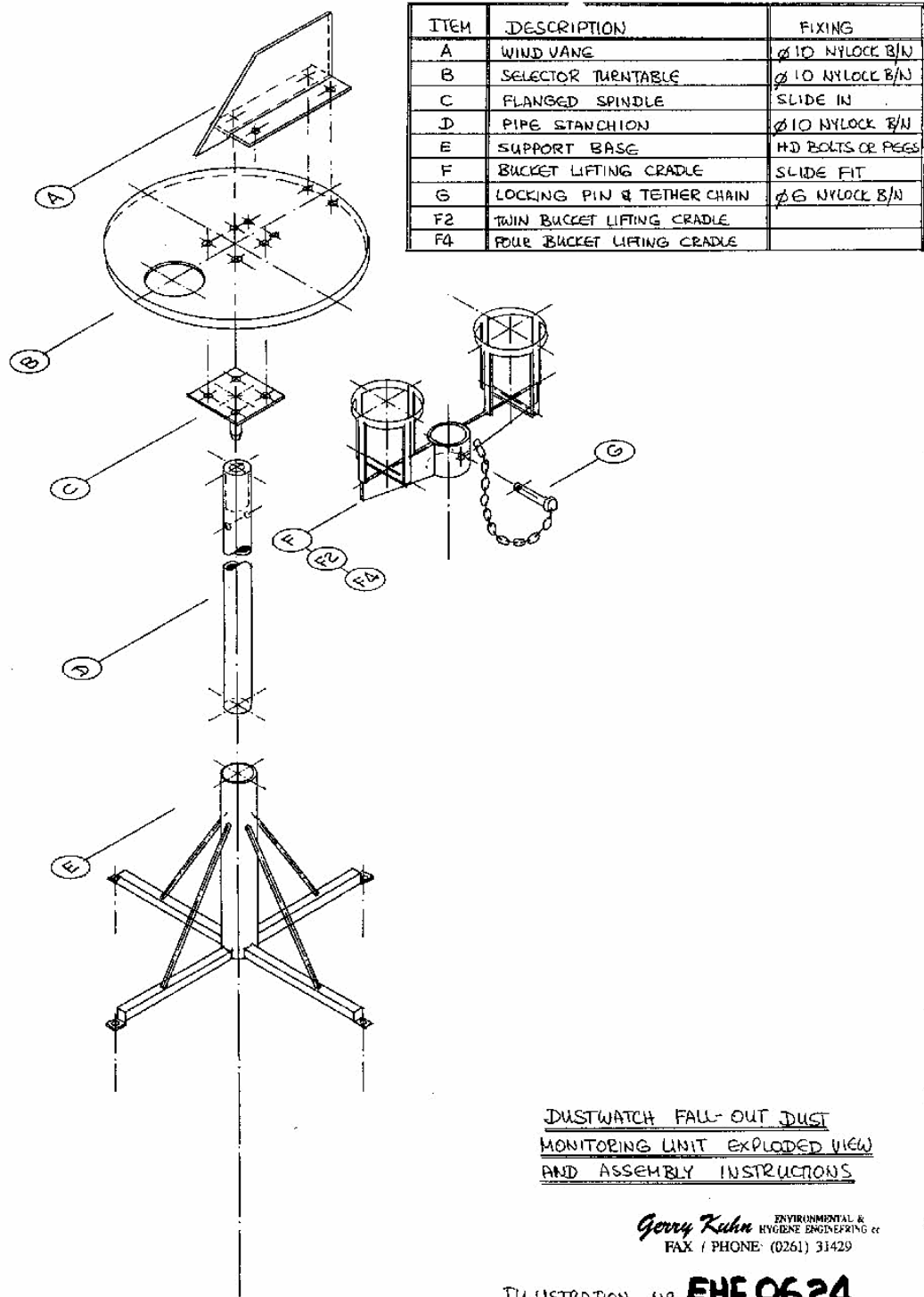

Figure 24: Exploded layout of the DustWatch unit

APPENDIX B. Filtering System Layout

Figure 25 is provided to assist with the understanding of the filtration process used to filter the water in the buckets onto a filter paper.

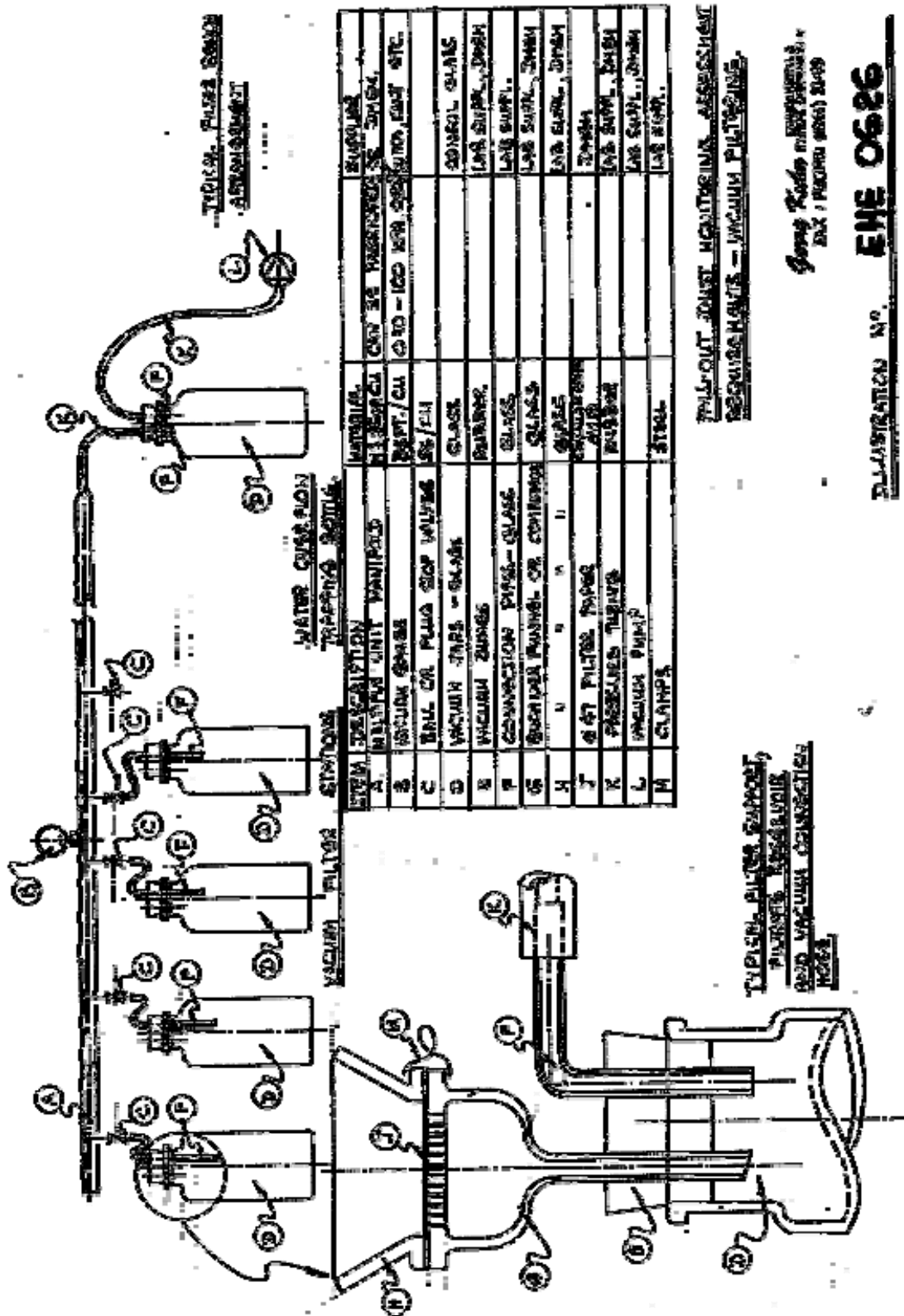

Figure 25: Filtering system layout and description

APPENDIX C. Precipitant Dust Data for the Smelting Industry

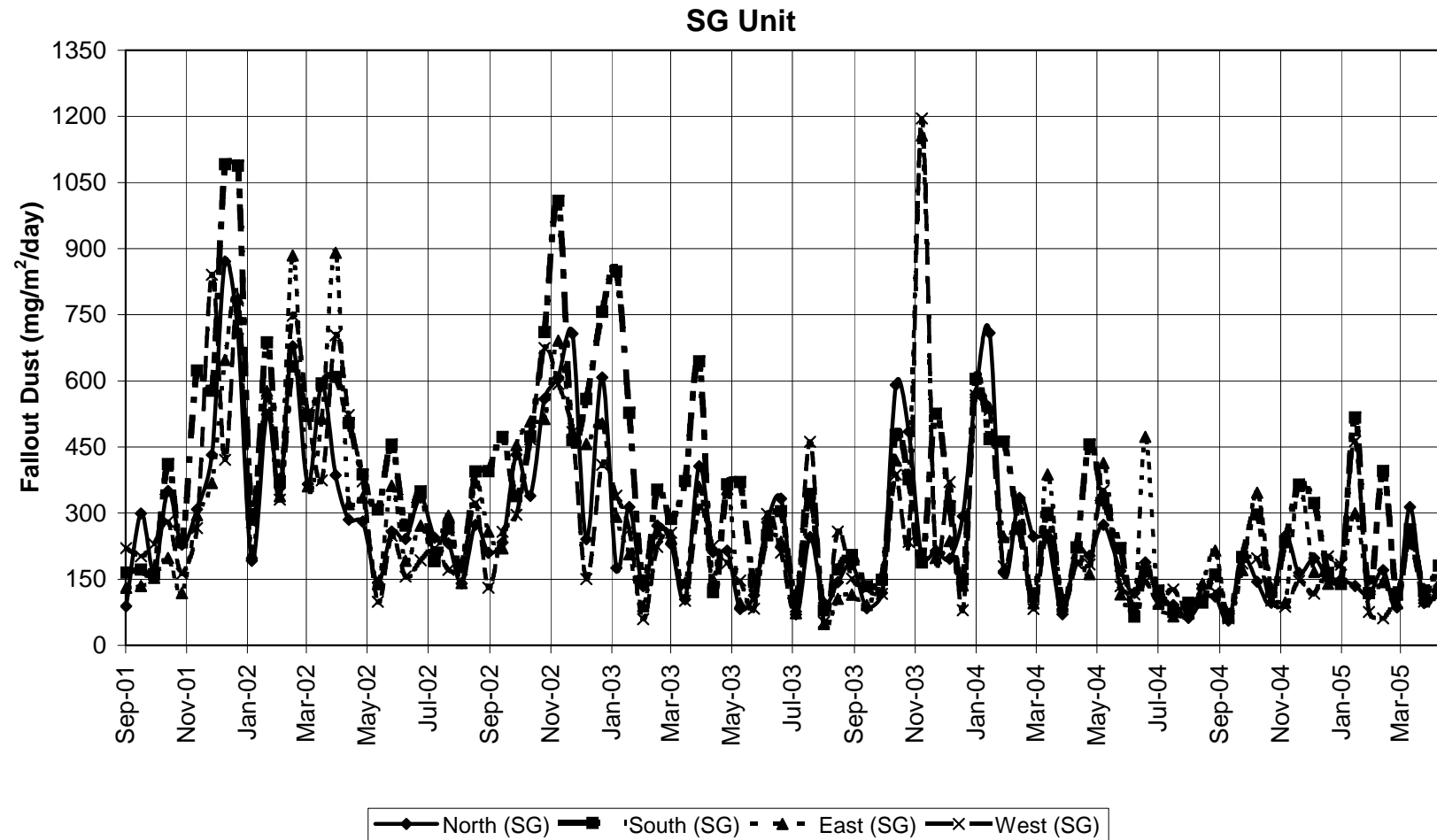

Figure 26: Precipitant dust data for the SG sampling area

SO Unit

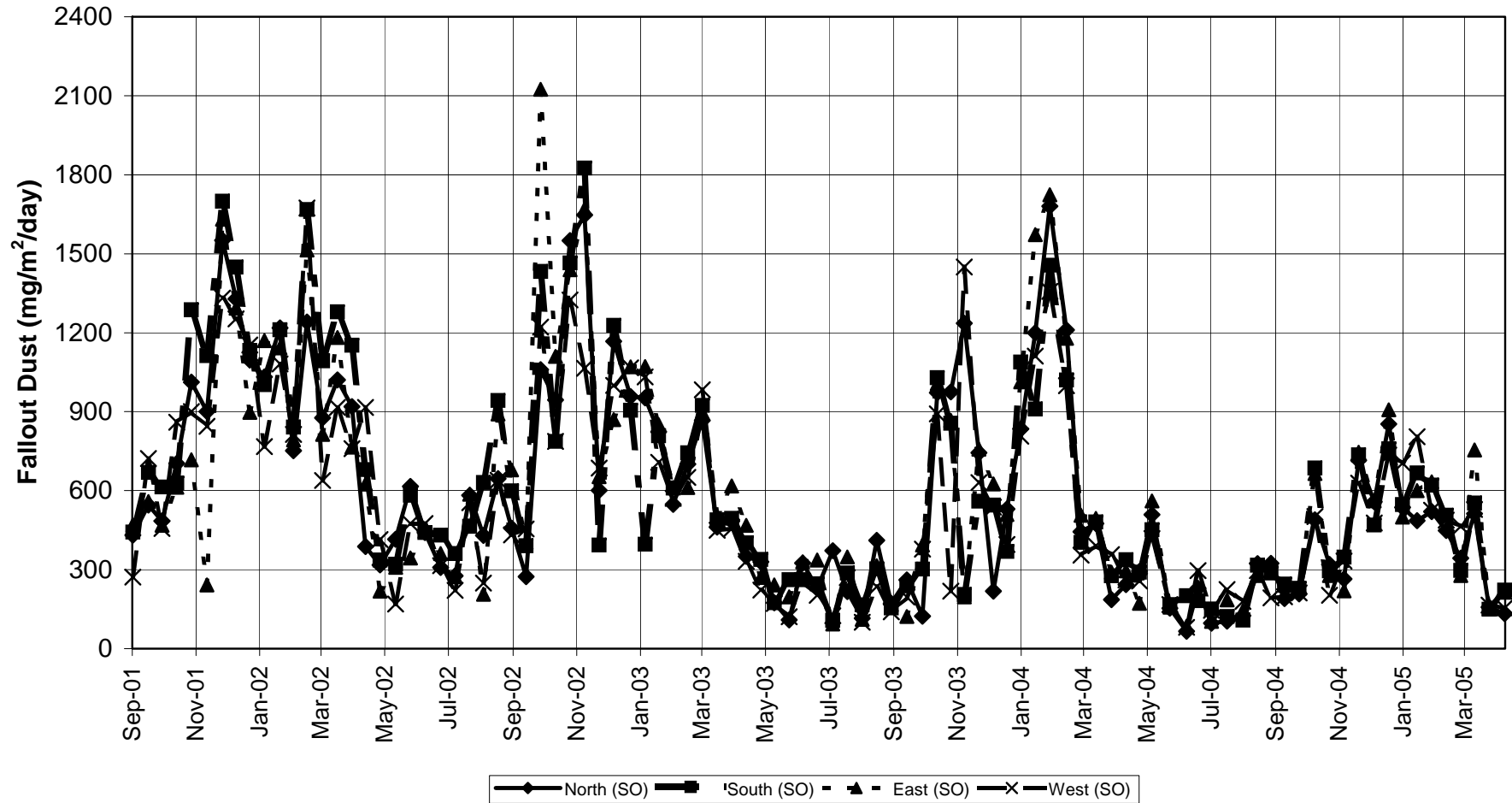

Figure 27: Precipitant dust data for the SO sampling area

APPENDIX D. Precipitant Dust Data for the Calcining Industry

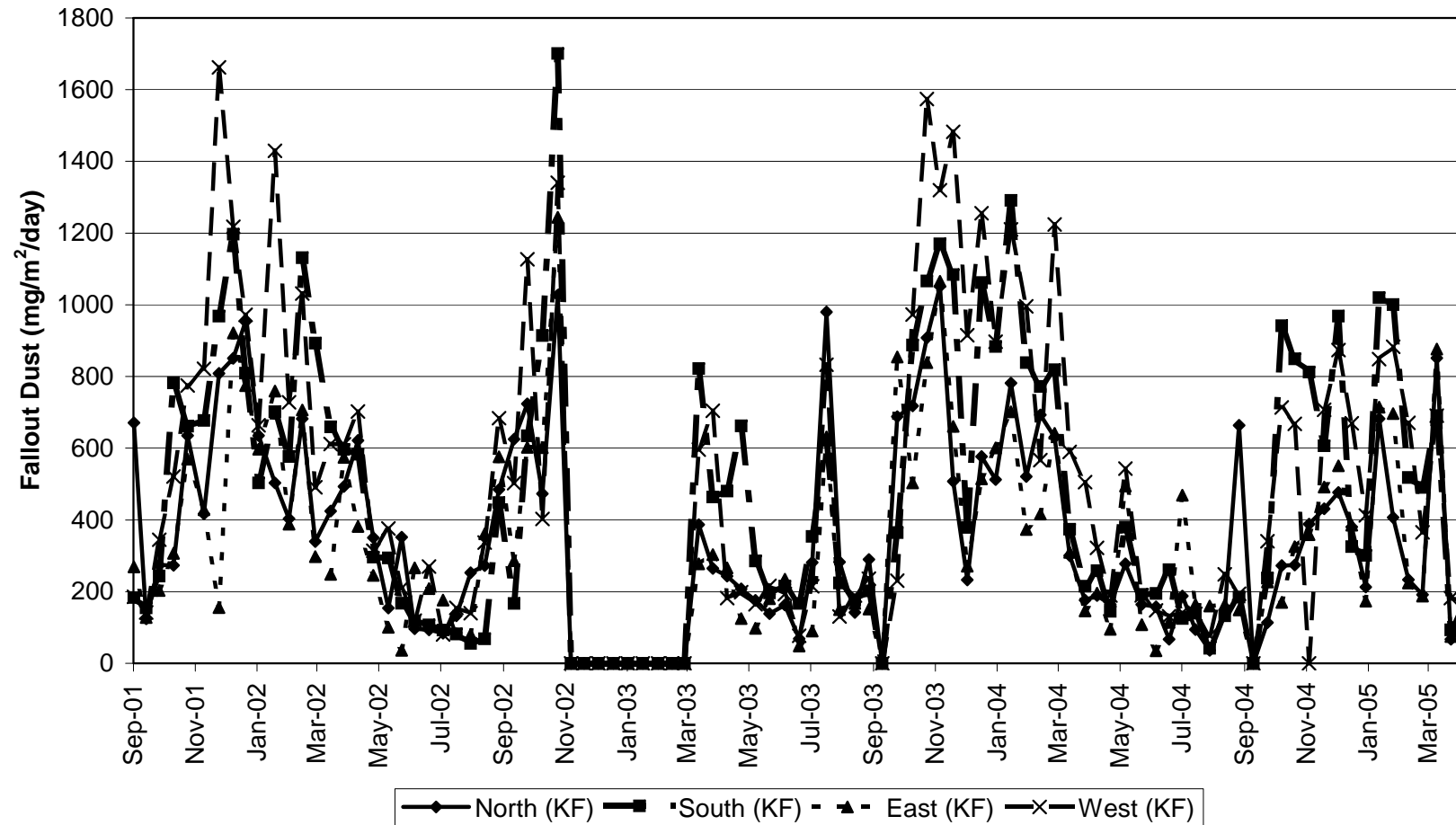

Figure 28: Precipitant dust data for the KF sampling area

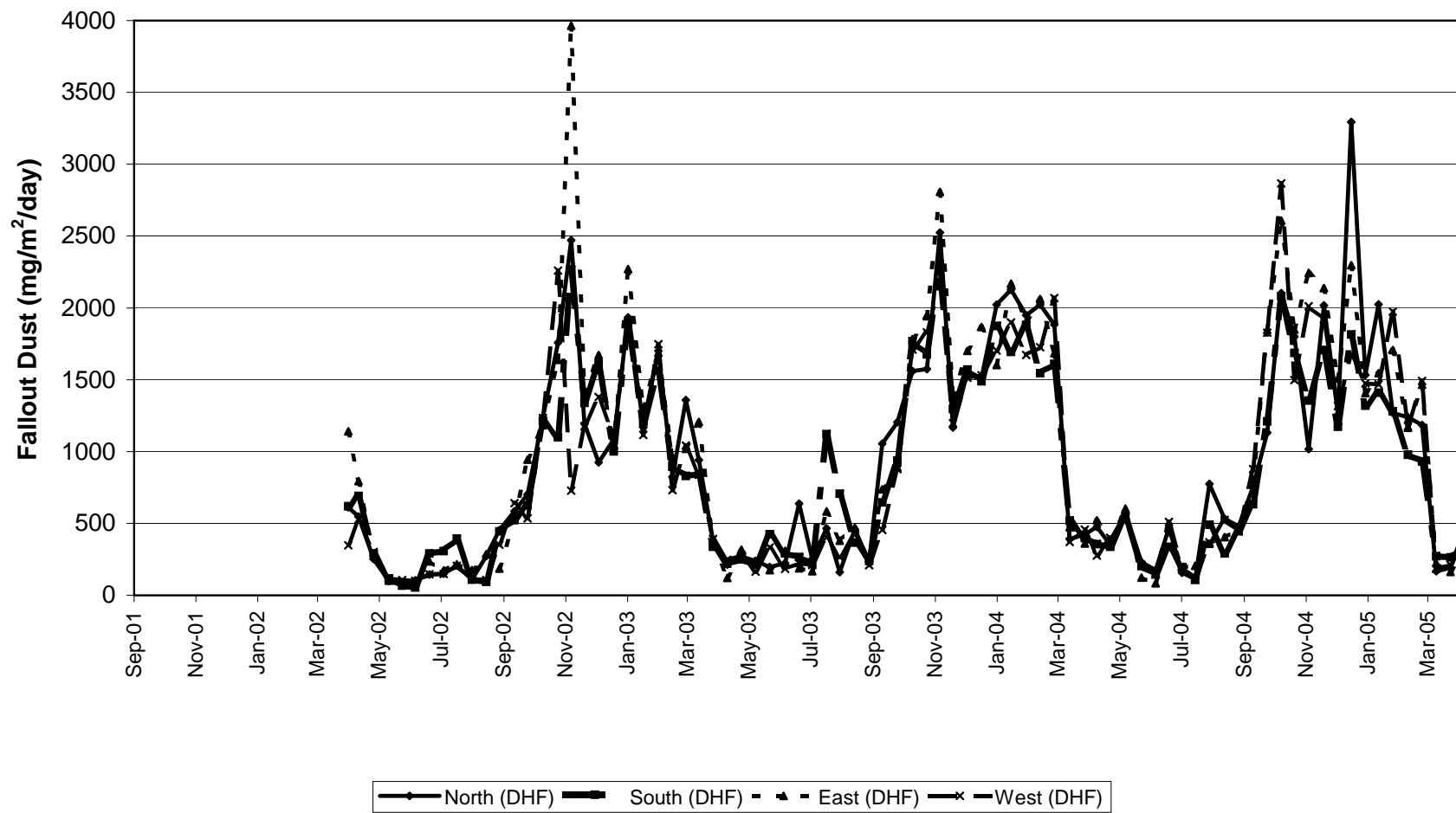

Figure 29: Precipitant dust data for the DHF sampling area

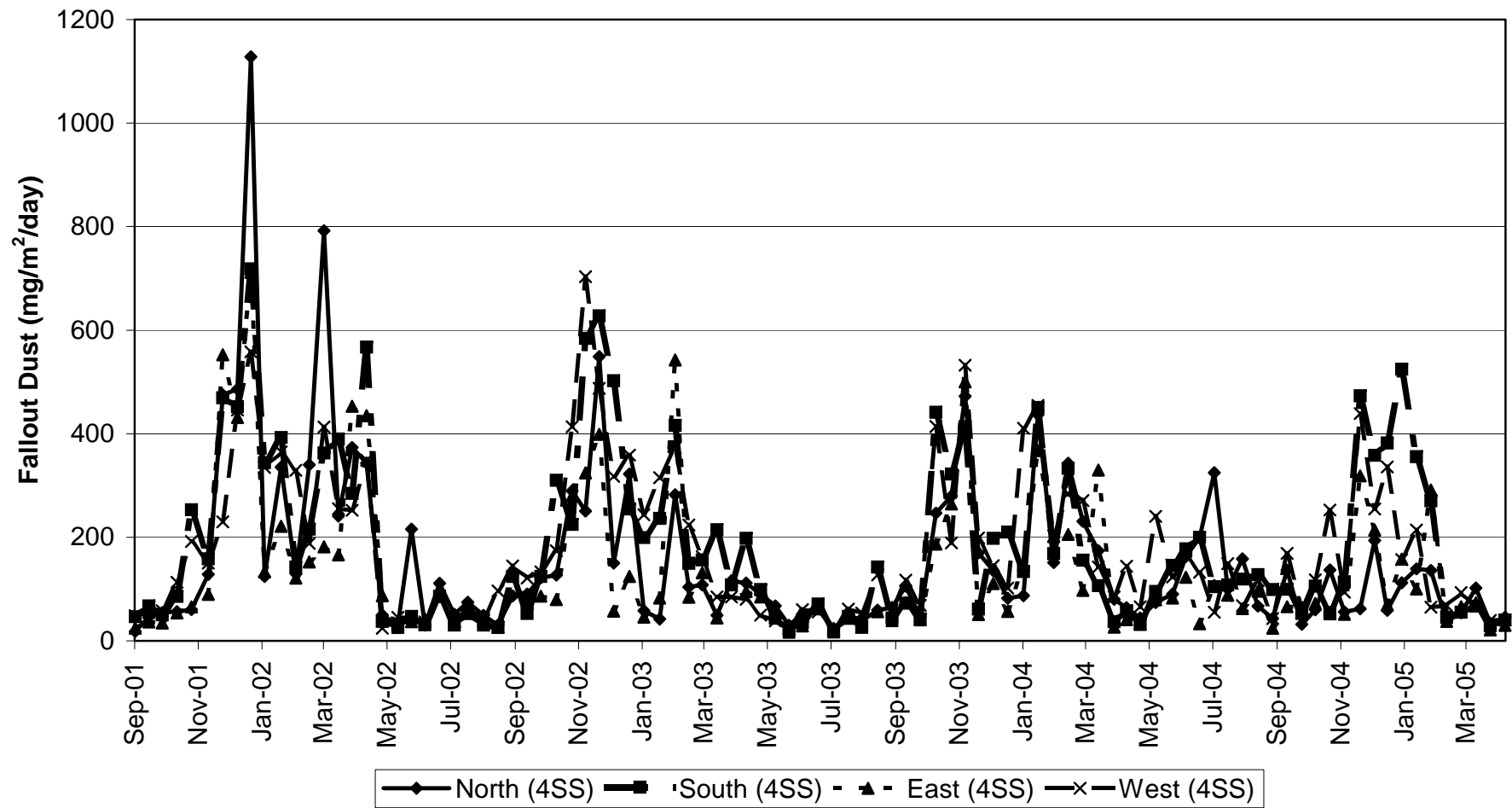

Figure 30: Precipitant dust data for the 4SS sampling area

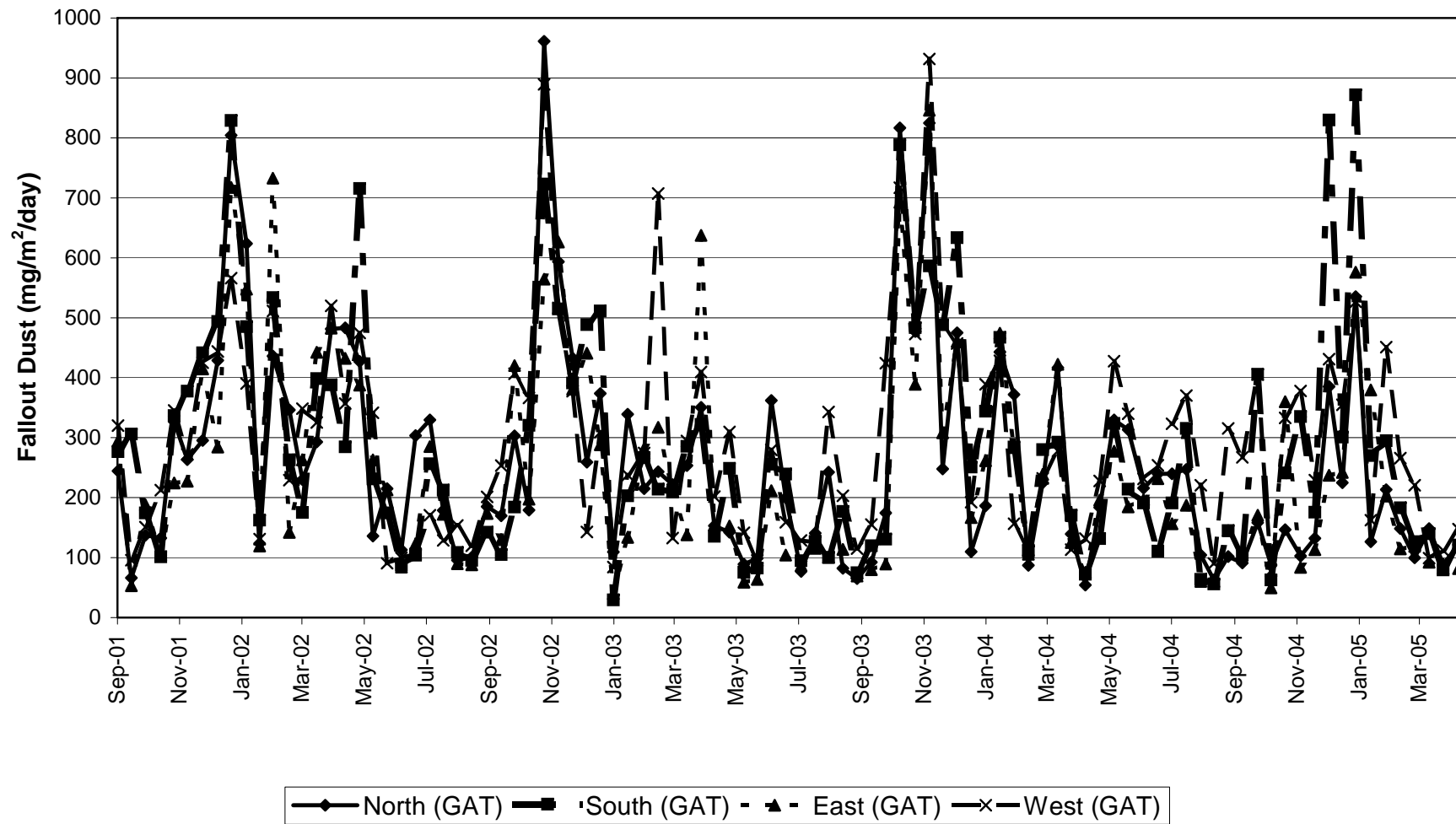

Figure 31: Precipitant dust data for the GAT sampling area

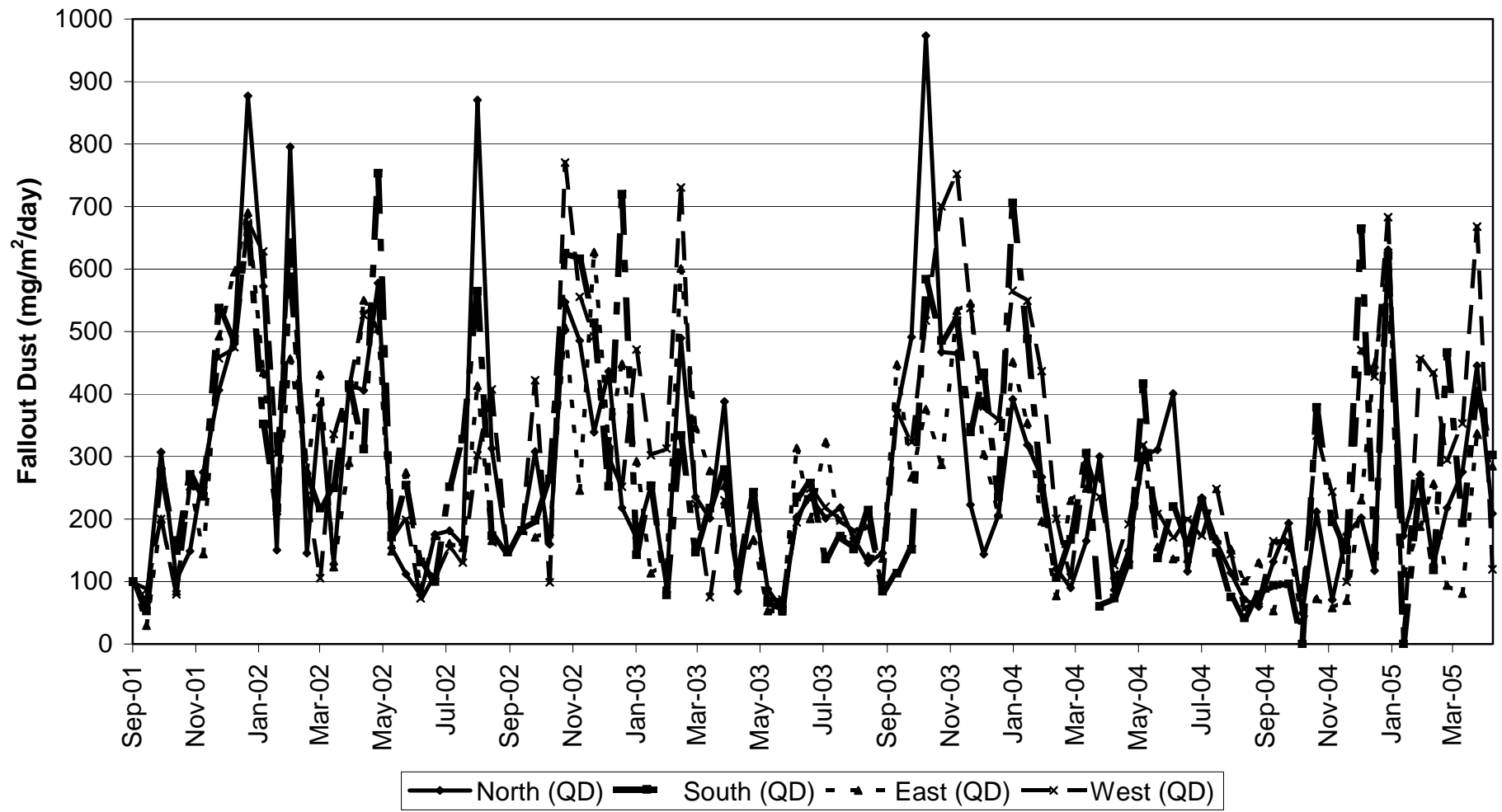

Figure 32: Precipitant dust data for the QD sampling area

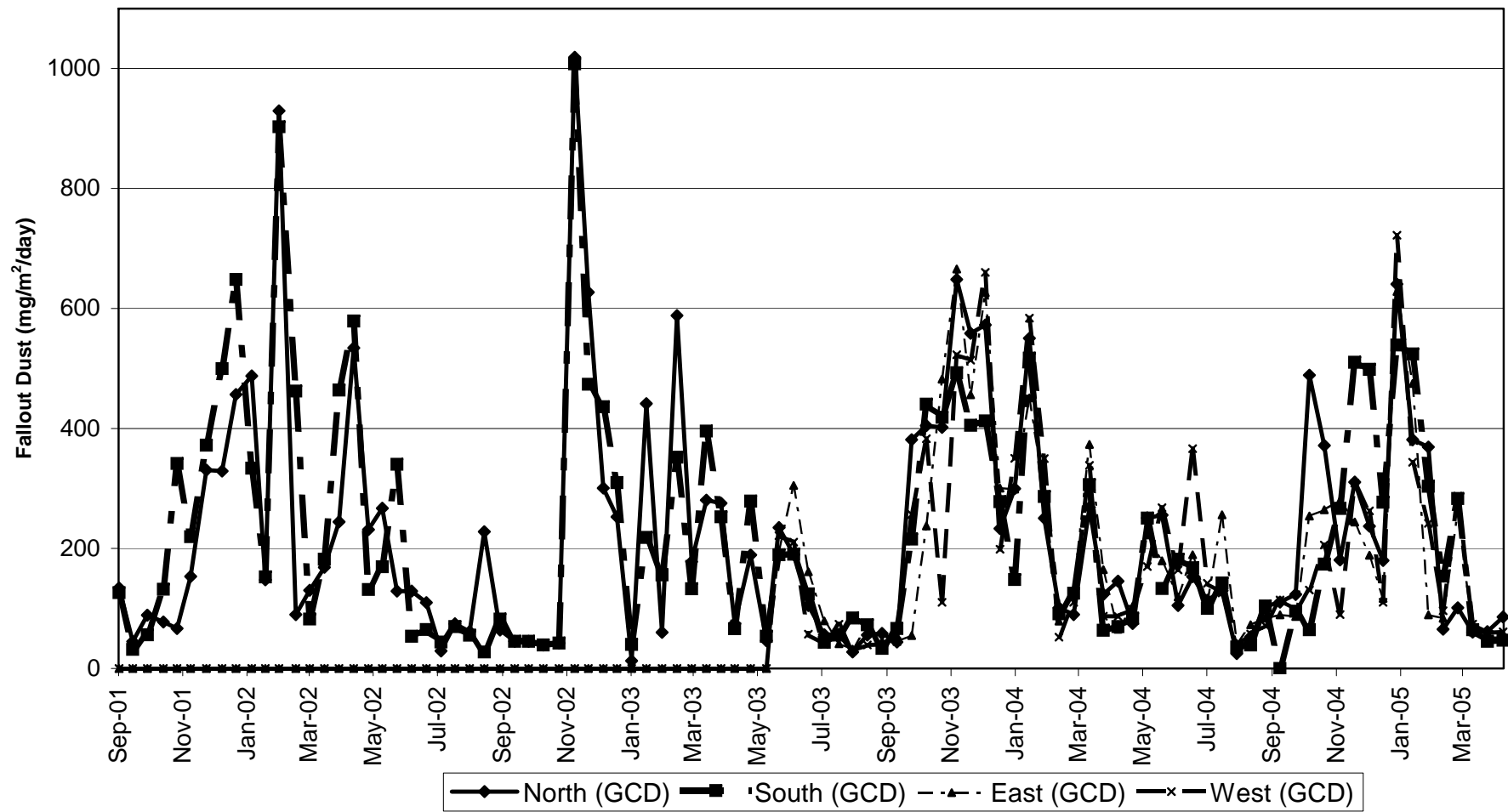

Figure 33: Precipitant dust data for the GCD sampling area

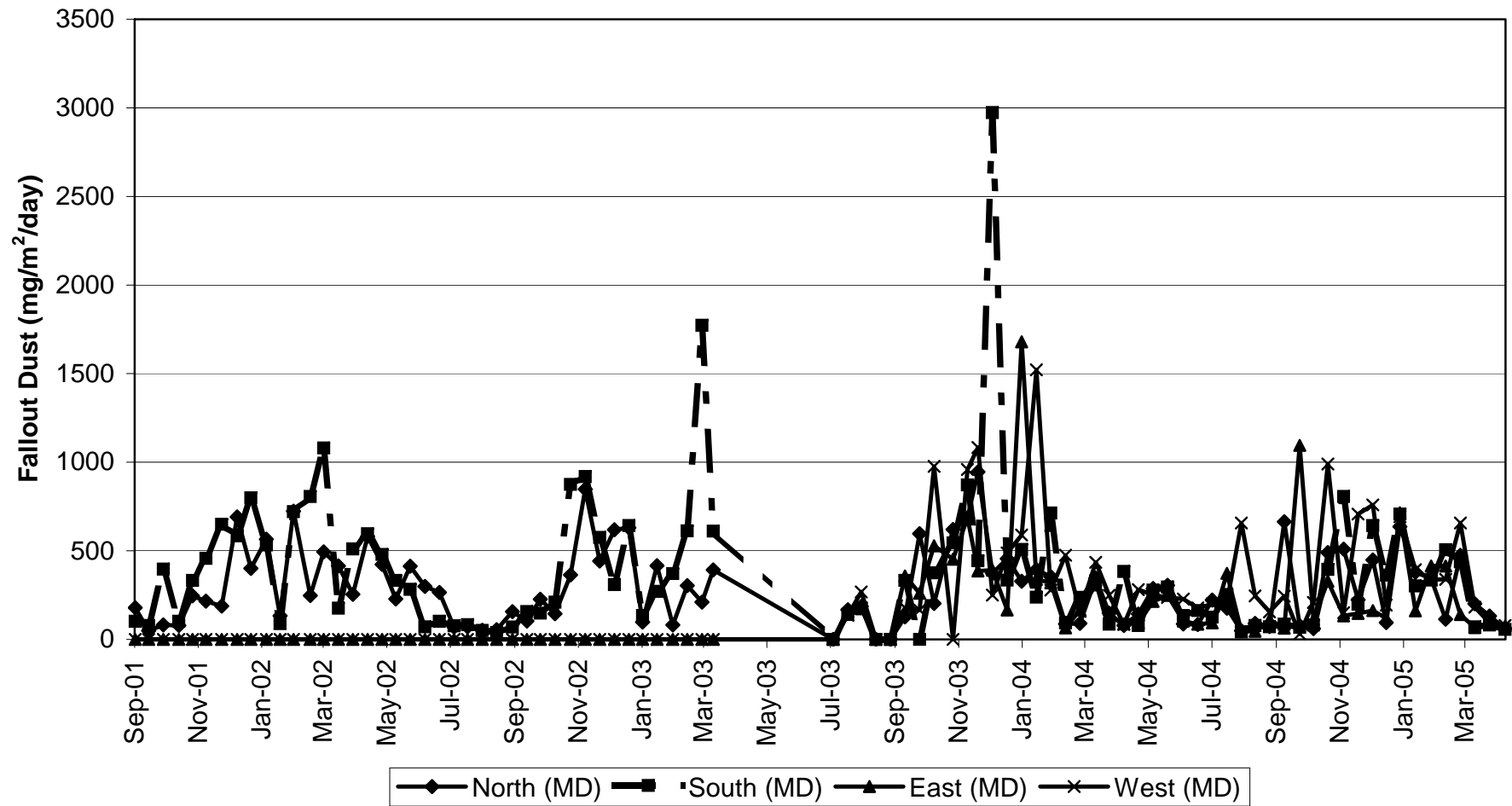

Figure 34: Precipitant dust data for the MD sampling area

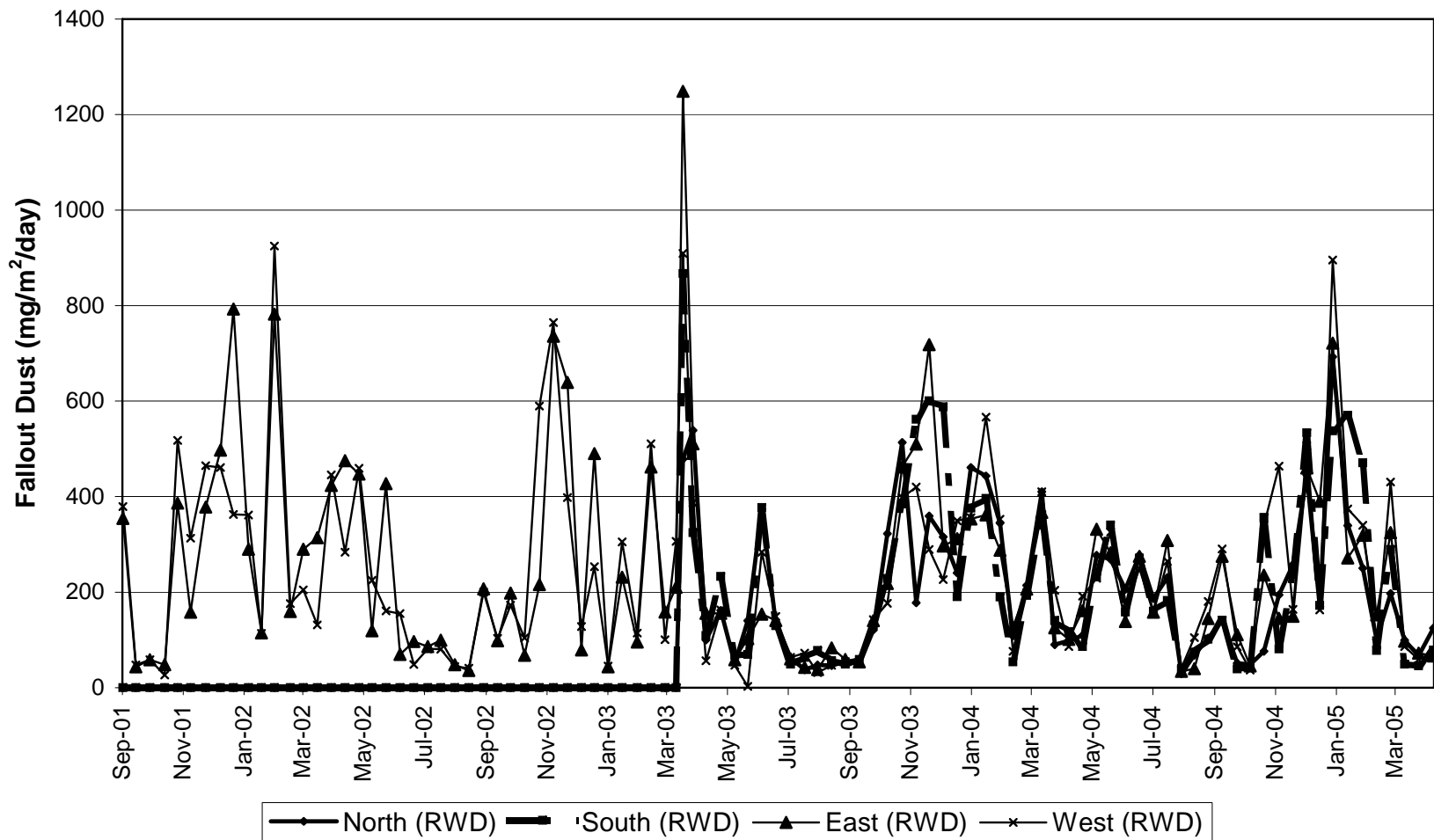

Figure 35: Precipitant dust data for the RWD sampling area

APPENDIX E. Ethics form from the Ethics Committee

Human Research Ethics Committee (Medical)
(formerly Committee for Research on Human Subjects (Medical))

Secretariat: Research Office, Room SH10005, 10th floor, Senate House • Telephone: +27 11 717-1234 • Fax: +27 11 339-5708
Private Bag 3, Wits 2050, South Africa

University
of the Witwatersrand,
Johannesburg



PC-J/465/dsk10es

13 August 2005

TO WHOM IT MAY CONCERN:

re: **Fall-out dust levels around two enterprises in the Western Cape of South Africa from 2001 to 2005**

Name: **Christopher Loans**

Degree: **Master of Public Health - Occupational Hygiene - Part-time**

This certifies that this project does not require clearance from the Human Research Ethics Committee (Medical).

The research will involve collection of dust monitoring data; no human subjects will be involved.

Yours faithfully

A handwritten signature in blue ink, appearing to read "Peter Cleaton-Jones".

Professor Peter Cleaton-Jones
Chair: Human Research Ethics Committee (Medical)

copy: Anisa Keshav, Research Office, Senate House, Wits